



rural development & agrarian reform

Department:
Rural Development & Agrarian Reform
PROVINCE OF THE EASTERN CAPE

EASTERN CAPE PROVINCIAL GOVERNMENT

DEPARTMENT OF RURAL DEVELOPMENT AND AGRARIAN REFORM

BID DOCUMENT FOR THE SUPPLY AND DELIVERY OF FENCING MATERIAL TO FARMS IN ENOCH MGIJIMA LOCAL MUNICIPALITY OF THE CHRIS HANI DISTRICT IN THE EASTERN CAPE PROVINCE

SCMU8 - 21/22 - 0032

LOCATION: Ntuthuko CPA, Tyhila Farm.

Directorate: Supply Chain Management DEPARTMENT OF RURAL DEVELOPMENT & AGRARIAN REFORM Chris Hani District Block H Komani Office Park Komani Hospital Queenstown 5320 Contact: Name: Mrs N. Mquqwana/ Mrs N. Ntshona Telephone: 079 495 7131/ (045) 807 7007	Directorate: Engineering Services DEPARTMENT OF RURAL DEVELOPMENT & AGRARIAN REFORM Private Bag X 7187 QUEENSTOWN 5320 Contact: Name: Mr. DCJ de Villiers Telephone: (045) 807 7000 / 083 294 4381 Email: dirk.devilliers@drdar.gov.za
Closing Date: 21/04/2021	Time: 11H00
Tenderer: _____	
CSD Number: _____	
LOGIS Number: _____	
Preference Points Claimed: _____	
Proposed Period for Completion: _____	
Total of the prices inclusive of applicable taxes: R _____	

The Tender

EASTERN CAPE PROVINCIAL GOVERNMENT

DEPARTMENT OF RURAL DEVELOPMENT AND AGRARIAN REFORM

**BID DOCUMENT FOR THE SUPPLY AND DELIVERY OF FENCING MATERIAL
TO FARMS IN ENOCH MGIJIMA LOCAL MUNICIPALITY OF THE CHRIS HANI
DISTRICT.**

Contents

Number | Heading

The Tender

Part 1: Tendering procedures

1.1 | Tender Notice and Invitation to Tender

1.2 | Bid Rules

Part 2: Returnable documents

2.1 | List of Returnable Documents

The Contract

Part 1: Agreement and Contract Data

1.1 | Form of Offer and Acceptance

1.2 | Form of Guarantee

Part 2: Pricing data

2.1 | Pricing Instructions

2.2 | Bills of Quantities

Part 3: Specifications

3.1 | Specifications of Fencing Material and Tools

Part 4: Conditions of Contract

4.1 | Conditions of Contract and Special Conditions of Contract

PART 1: TENDERING PROCEDURES

1.1

Tender Notice and Invitation to Tender

EASTERN CAPE PROVINCIAL GOVERNMENT

DEPARTMENT OF RURAL DEVELOPMENT AND AGRARIAN REFORM

BID DOCUMENT FOR THE SUPPLY AND DELIVERY OF FENCING MATERIAL TO FARMS IN ENOCH MGIJIMA LOCAL MUNICIPALITY OF THE CHRIS HANI DISTRICT.

T1.1 Tender Notice and Invitation to Tender

1.	<p>The Department of Rural Development and Agrarian Reform, Eastern Cape Provincial Government, invites tenders for Supply and delivery of fencing material.</p> <p>The works shall include the following:</p> <ul style="list-style-type: none">• Supply and deliver fencing material as per bill of quantities to the site at Ntuthuko CPA, Enoch Mgiijima Local Municipality. Co-ordinates:• Supply and deliver fencing material as per bill of quantities to the site at Tyhila farm, Enoch Mgiijima Local Municipality. Co-ordinates:
2.	<p>Tender documents will be available during working hours after 08:00 as of till the day before the tenders close, from the offices of the Assistant Manager Supply Chain Management on payment of a non-refundable deposit of R100.00 per set of documents. Bank certified cheques must be made payable to “Department of Rural Development and Agrarian Reform” or can be downloaded free of charge from the Departmental website (www.drdr.gov.za) or https://etenders.treasury.gov.za/.</p> <p>The physical address for collection of tender documents is:</p> <p>Block H Komani Office Park Komani Hospital Queenstown 5320</p>
3.	<p>No site inspection or clarification meeting will be held. It is the responsibility of prospective tenderers to familiarize themselves with the conditions of the roads and site, as coordinates have been provided. Prospective tenderers are welcome to contact the technician responsible for the project on any information required. The technician’s details are indicated at point 21 below.</p>
4.	<p>The completed tender document and any supporting documentation shall be placed in a single sealed envelope clearly marked “CONTRACT NO: SCMU8 - 21/22 - 0032 / BID DOCUMENT FOR THE SUPPLY AND DELIVERY OF FENCING MATERIAL TO FARMS IN ENOCH MGIJIMA LOCAL MUNICIPALITY.</p> <p>and deposited in the tender box at: Supply Chain Management, Block H, Komani Office Park, Komani Hospital, Queenstown 5320, not later than 11:00 on 21/04/2021 when the tender box will close.</p> <p>Tenderers should ensure that tender documents are delivered timeously to the correct address. If the tender is late, it will not be accepted for consideration.</p>

5.	<i>Tenders will NOT be opened in public due to the Covid-19 pandemic and to adhere to Social Distancing, opening registers will be uploaded on DRDAR website and can be e-mailed to bidder on written request.</i>																														
6.	All submitted certificates must be valid for 90 days after the Tender Closing Date.																														
7.	Contractors must take special note that they must comply to the Disaster Management Act (57/2002): Covid-19 Occupational Health and Safety Measures in Workplaces Covid-19 (C19 OHS), 2020																														
8.	In terms of Preferential Procurement Regulation of 2017 the 80/20 preference point system is applicable.																														
9.	<p>Broad-Based Black Economic Empowerment (B-BBEE) requires that tenderers submit original and valid B-BBEE Status Level Verification Certificates or certified copies thereof to substantiate their B-BBEE rating claims. Failure to submit such a certificate will result in the tenderer not qualifying for preference points for B-BBEE. The tenderers must submit verification certificates that are accredited by:</p> <ul style="list-style-type: none"> • SANAS (South African National Accredited System). • Sworn affidavit. <p>In terms of Regulation 5 (2) and 6 (2) of the Preferential Procurement Regulations, preference points must be awarded to a tenderer for attaining the B-BBEE status level of contribution in accordance with the table below:</p> <table border="1" data-bbox="288 994 1485 1408"> <thead> <tr> <th>B-BBEE Status Level of Contributor</th> <th>Number of points (90/10 system)</th> <th>Number of points (80/20 system)</th> </tr> </thead> <tbody> <tr> <td>1</td> <td>10</td> <td>20</td> </tr> <tr> <td>2</td> <td>9</td> <td>18</td> </tr> <tr> <td>3</td> <td>6</td> <td>14</td> </tr> <tr> <td>4</td> <td>5</td> <td>12</td> </tr> <tr> <td>5</td> <td>4</td> <td>8</td> </tr> <tr> <td>6</td> <td>3</td> <td>6</td> </tr> <tr> <td>7</td> <td>2</td> <td>4</td> </tr> <tr> <td>8</td> <td>1</td> <td>2</td> </tr> <tr> <td>Non-compliant contributor</td> <td>0</td> <td>0</td> </tr> </tbody> </table> <p>A trust, consortium or joint venture must obtain and submit a consolidated B-BBEE Status Level Verification Certificate with their tenders.</p>	B-BBEE Status Level of Contributor	Number of points (90/10 system)	Number of points (80/20 system)	1	10	20	2	9	18	3	6	14	4	5	12	5	4	8	6	3	6	7	2	4	8	1	2	Non-compliant contributor	0	0
B-BBEE Status Level of Contributor	Number of points (90/10 system)	Number of points (80/20 system)																													
1	10	20																													
2	9	18																													
3	6	14																													
4	5	12																													
5	4	8																													
6	3	6																													
7	2	4																													
8	1	2																													
Non-compliant contributor	0	0																													
10.	<p>All tenderers must be registered on the National Treasury Centralized Suppliers Data Base, on the EC LOGIS system and the CIDB before the closing date of tenders and provide the information.</p> <p><u>Invalid or non-submission of the following documents will render the Bidder disqualified:</u></p> <ul style="list-style-type: none"> ➤ <u>Tax compliance status and company directors of bidders will be verified on CSD for all price quotations and bids. Hard copies of Tax Clearance Certificate and CK documents are therefore no longer needed to be attached in the bid.</u> ➤ Company Profile ➤ JV Agreement (if Applicable) ➤ Proof of CSD registration (active & recently updated) ➤ Proof of registration on the LOGIS system (active & recently updated) 																														
11.	Part of the works cannot be sub contracted without prior approval from the Engineer.																														

12.	<p>All bidders must ensure that they comply with the designated sectors for “Local Content ECBD 6.2”. The SABS standard approved technical specification number SATS 1286:2011 and the Guidance on the Calculation of Local Content together with the Local Content Declaration Templates [Annex C, D and E] are available on the DTI’s official website. http://www.thedti.gov.za/industrial_development/ip.jsp at no cost.</p> <p>Minimum content threshold for local products for</p> <ul style="list-style-type: none"> ➤ Steel Products and Components for Construction (Fencing materials, Fencing Tools and Gates) = 100% <p>Bidders are required to achieve a stipulated minimum threshold for local production and content as per DTI designated sector as per section 8 of the PPPFA Regulation of 2017. Industry Sector: Steel Products and Components for Construction (100%). Bidders must complete SBD6.2 with Annexure C and must be submitted with the quote. Failure to submit will invalidate the bid.</p>
13.	The tender with the lowest price or any tender offer will not necessarily be accepted.
14.	For a project to the value of R 3.0 million and more, a Bidder/Contractor who is not from the Eastern Cape Province, must sub-contract 25% of the contract value to a Bidder/Contractor within the Eastern Cape Province.
15.	All tenders must be submitted on the official forms – (not to be re-typed). Telephonic, telegraphic, e-mail or facsimile will not be accepted.
16.	Failure to supply all supplementary information, certificates and documentation may result in the tender being rendered non-responsive.
17.	This tender is subject to the National Treasury General Conditions of Contract (July 2010) and, if applicable, any other Special Conditions of Contract (SCC).
18.	<p>Bidders must submit in terms of point 17 above, the following with the bid submission:</p> <ul style="list-style-type: none"> i) Proof of the CSD registration of the subcontractor(s). ii) BBBEE certificate/affidavit of the subcontractor(s). iii) Provide details of which items in the bill of quantities will be part of the subcontracting agreement.
19.	NB: Bidders should note that this forms part of a batch of tenders included into the DRDAR infrastructure program within the Eastern Cape; the employer reserves the right not to award more than TWO projects to be executed simultaneously within the province. The department as a procuring entity will conduct a risk assessment based on amounts and nature of the commodity for the final decision vs the bidders capacity.
20.	<p>Administrative enquiries should be directed to:</p> <p>Name: Mrs N. Mquqwana/ Mrs N. Khowa Telephone: 079 495 7131/ (045) 807 7007</p>
21.	<p>Technical enquiries should be directed to:</p> <p>Name: Mr. DCJ de Villiers Telephone: (045) 807 7000 / 083 294 4381 Email: dirk.devilliers@drdar.gov.za</p>

The Department of Rural Development and Agrarian Reform adheres to all relevant Acts including the Black Economic Empowerment Act No. 53 of 2003, the Preferential Procurement Policy Framework Act No. 5 of 2000 and the Employment Equity Act No. 55 of 1998.

YOU ARE HEREBY INVITED TO BID FOR REQUIREMENTS OF THE (NAME OF DEPARTMENT/ PUBLIC ENTITY)					
BID NUMBER:	SCMU8 - 21/22 - 0032	CLOSING DATE:	21/04/2021	CLOSING TIME:	11:00
DESCRIPTION	BID DOCUMENT FOR THE SUPPLY AND DELIVERY OF FENCING MATERIAL TO FARMS IN ENOCH MJIGIMA LOCAL MUNICIPALITY				
BID RESPONSE DOCUMENTS MAY BE DEPOSITED IN THE BID BOX SITUATED AT (STREET ADDRESS)					
Block H					
Komani Office Park					
Komani Hospital					
Queenstown					
BIDDING PROCEDURE ENQUIRIES MAY BE DIRECTED TO			TECHNICAL ENQUIRIES MAY BE DIRECTED TO:		
CONTACT PERSON	Mrs N. Mquqwana		CONTACT PERSON	Mr. DCJ de Villiers	
TELEPHONE NUMBER	079 495 7131		TELEPHONE NUMBER	083 294 4381	
FACSIMILE NUMBER			FACSIMILE NUMBER		
E-MAIL ADDRESS	Nokude.mquqwana@drdar.gov.za		E-MAIL ADDRESS	dirk.devilliers@drdar.gov.za	
SUPPLIER INFORMATION					
NAME OF BIDDER					
POSTAL ADDRESS					
STREET ADDRESS					
TELEPHONE NUMBER	CODE		NUMBER		
CELL PHONE NUMBER					
FACSIMILE NUMBER	CODE		NUMBER		
E-MAIL ADDRESS					
VAT REGISTRATION NUMBER					
SUPPLIER COMPLIANCE STATUS	TAX COMPLIANCE SYSTEM PIN:		OR	CENTRAL SUPPLIER DATABASE No:	MAAA _____
B-BBEE STATUS LEVEL VERIFICATION CERTIFICATE	TICK APPLICABLE BOX] <input type="checkbox"/> Yes <input type="checkbox"/> No		B-BBEE STATUS LEVEL SWORN AFFIDAVIT	[TICK APPLICABLE BOX] <input type="checkbox"/> Yes <input type="checkbox"/> No	
[A B-BBEE STATUS LEVEL VERIFICATION CERTIFICATE/ SWORN AFFIDAVIT (FOR EMES & QSEs) MUST BE SUBMITTED IN ORDER TO QUALIFY FOR PREFERENCE POINTS FOR B-BBEE]					
1. ARE YOU THE ACCREDITED REPRESENTATIVE IN SOUTH AFRICA FOR THE GOODS /SERVICES /WORKS OFFERED?	<input type="checkbox"/> Yes <input type="checkbox"/> No [IF YES ENCLOSE PROOF]		2. ARE YOU A FOREIGN BASED SUPPLIER FOR THE GOODS /SERVICES /WORKS OFFERED?	<input type="checkbox"/> Yes <input type="checkbox"/> No [IF YES, ANSWER PART B:3]	
QUESTIONNAIRE TO BIDDING FOREIGN SUPPLIERS					
IS THE ENTITY A RESIDENT OF THE REPUBLIC OF SOUTH AFRICA (RSA)?				<input type="checkbox"/> YES <input type="checkbox"/> NO	
DOES THE ENTITY HAVE A BRANCH IN THE RSA?				<input type="checkbox"/> YES <input type="checkbox"/> NO	
DOES THE ENTITY HAVE A PERMANENT ESTABLISHMENT IN THE RSA?				<input type="checkbox"/> YES <input type="checkbox"/> NO	
DOES THE ENTITY HAVE ANY SOURCE OF INCOME IN THE RSA?				<input type="checkbox"/> YES <input type="checkbox"/> NO	
IS THE ENTITY LIABLE IN THE RSA FOR ANY FORM OF TAXATION?				<input type="checkbox"/> YES <input type="checkbox"/> NO	
IF THE ANSWER IS "NO" TO ALL OF THE ABOVE, THEN IT IS NOT A REQUIREMENT TO REGISTER FOR A TAX COMPLIANCE STATUS SYSTEM PIN CODE FROM THE SOUTH AFRICAN REVENUE SERVICE (SARS) AND IF NOT REGISTER AS PER 2.3 BELOW.					

PART B TERMS AND CONDITIONS FOR BIDDING

1. BID SUBMISSION:

- 1.1. BIDS MUST BE DELIVERED BY THE STIPULATED TIME TO THE CORRECT ADDRESS. LATE BIDS WILL NOT BE ACCEPTED FOR CONSIDERATION.
- 1.2. ALL BIDS MUST BE SUBMITTED ON THE OFFICIAL FORMS PROVIDED- (NOT TO BE RE-TYPED) OR IN THE MANNER PRESCRIBED IN THE BID DOCUMENT.
- 1.3. BIDDERS MUST REGISTER ON THE CENTRAL SUPPLIER DATABASE (CSD) TO UPLOAD MANDATORY INFORMATION NAMELY: (BUSINESS REGISTRATION/ DIRECTORSHIP/ MEMBERSHIP/IDENTITY NUMBERS; TAX COMPLIANCE STATUS; AND BANKING INFORMATION FOR VERIFICATION PURPOSES). B-BBEE CERTIFICATE OR SWORN AFFIDAVIT FOR B-BBEE MUST BE SUBMITTED TO BIDDING INSTITUTION.
- 1.4. WHERE A BIDDER IS NOT REGISTERED ON THE CSD, MANDATORY INFORMATION NAMELY: (BUSINESS REGISTRATION/ DIRECTORSHIP/ MEMBERSHIP/IDENTITY NUMBERS; TAX COMPLIANCE STATUS MAY NOT BE SUBMITTED WITH THE BID DOCUMENTATION. B-BBEE CERTIFICATE OR SWORN AFFIDAVIT FOR B-BBEE MUST BE SUBMITTED TO BIDDING INSTITUTION.
- 1.5. THIS BID IS SUBJECT TO THE PREFERENTIAL PROCUREMENT POLICY FRAMEWORK ACT, 2000 AND THE PREFERENTIAL PROCUREMENT REGULATIONS, 2017, THE GENERAL CONDITIONS OF CONTRACT (GCC) AND, IF APPLICABLE, ANY OTHER SPECIAL CONDITIONS OF CONTRACT.
- 1.6. BIDDERS ARE REQUIRED TO ACHIEVE A STIPULATED MINIMUM THRESHOLD FOR LOCAL PRODUCTION AND CONTENT AS PER DTI DESIGNATED SECTOR AS PER SECTION 8 OF THE PPPFA REGULATION OF 2017. INDUSTRY SECTOR: STEEL PRODUCTS AND COMPONENTS FOR CONSTRUCTION (100%). BIDDERS MUST COMPLETE SBD6.2 WITH ANNEXURE C AND MUST BE SUBMITTED WITH THE QUOTE. FAILURE TO SUBMIT WILL INVALIDATE THE BID.
- 1.7. THE SUCCESSFUL BIDDER WILL BE REQUIRED TO FILL IN AND SIGN A WRITTEN CONTRACT FORM (SBD7).

2. TAX COMPLIANCE REQUIREMENTS

- 2.1 BIDDERS MUST ENSURE COMPLIANCE WITH THEIR TAX OBLIGATIONS.
- 2.2 BIDDERS ARE REQUIRED TO SUBMIT THEIR UNIQUE PERSONAL IDENTIFICATION NUMBER (PIN) ISSUED BY SARS TO ENABLE THE ORGAN OF STATE TO VERIFY THE TAXPAYER'S PROFILE AND TAX STATUS.
- 2.3 APPLICATION FOR TAX COMPLIANCE STATUS (TCS) PIN MAY BE MADE VIA E-FILING THROUGH THE SARS WEBSITE WWW.SARS.GOV.ZA.
- 2.4 BIDDERS MAY ALSO SUBMIT A PRINTED TCS CERTIFICATE TOGETHER WITH THE BID.
- 2.5 IN BIDS WHERE CONSORTIA / JOINT VENTURES / SUB-CONTRACTORS ARE INVOLVED, EACH PARTY MUST SUBMIT A SEPARATE TCS CERTIFICATE / PIN / CSD NUMBER.
- 2.6 WHERE NO TCS IS AVAILABLE BUT THE BIDDER IS REGISTERED ON THE CENTRAL SUPPLIER DATABASE (CSD), A CSD NUMBER MUST BE PROVIDED.
- 2.7 NO BIDS WILL BE CONSIDERED FROM PERSONS IN THE SERVICE OF THE STATE, COMPANIES WITH DIRECTORS WHO ARE PERSONS IN THE SERVICE OF THE STATE, OR CLOSE CORPORATIONS WITH MEMBERS PERSONS IN THE SERVICE OF THE STATE."

NB: FAILURE TO PROVIDE / OR COMPLY WITH ANY OF THE ABOVE PARTICULARS MAY RENDER THE BID INVALID.

SIGNATURE OF BIDDER:

CAPACITY UNDER WHICH THIS BID IS SIGNED:
(Proof of authority must be submitted e.g. company resolution)

DATE:

1.2

Bid Rules

EASTERN CAPE PROVINCIAL GOVERNMENT

DEPARTMENT OF RURAL DEVELOPMENT AND AGRARIAN REFORM

BID DOCUMENT FOR THE SUPPLY AND DELIVERY OF FENCING MATERIAL TO FARMS IN ENOCH MGJIMA LOCAL MUNICIPALITY OF THE CHRIS HANI DISTRICT.

1.1 Tender Notice and Invitation to Tender

1.1.1 Tender Notice

The Department of Rural Development and Agrarian Reform, Eastern Cape Provincial Government, invites tenders for Supply and delivery of fencing material.

The works shall include the following:

- Supply and deliver fencing material as per bill of quantities to the site at Ntuthuko CPA, Enoch Mgijima Local Municipality.
Co-ordinates:
- Supply and deliver fencing material as per bill of quantities to the site at Tyhila farm, Enoch Mgijima Local Municipality.
Co-ordinates:

TENDER RULES AND REQUIREMENTS:

1. Bid Documents

The Bidder shall satisfy himself that the documents received are correct, complete and sufficient to be the basis of a *bona fide* tender. Bidders shall check the numbers of the pages and satisfy themselves that none are missing or duplicated. No liability shall be accepted in regard to claims arising from the fact that pages are missing or duplicated. Should a Bidder not accept that the documents issued can form the basis of a *bona fide* bid, the Deputy Director SCM Nokude.Mquqwana@drdar.gov.za shall be requested to correct the discrepancy, ambiguity, missing or illegible information prior to the submission of bids? The submission of a *bona fide* bid shall absolve the Employer, Deputy Director SCM, from any liability whatsoever for any error in a bid due to the foregoing.

Furthermore, no request for the revision of the Bid Sum as a result of such error shall be considered by the Employer after the closing date and hour set for the submission of bids.

2. Submission of Bids

Clearly marked bids in sealed envelopes shall be submitted at the place and **before the closing time** stated in the Bid Notice.

Electronic, faxed, or telegraphic bids will not be accepted.

3. Deposit on Documents

The deposit on bid documents will not be refunded.

4. Notice to Bidders

Should any additions or alterations to the documents as issued to bidders be deemed necessary prior to the date for submission of bids, these will be issued to bidders in the form of Notices to Bidders and these will form part of the bid document.

The Notices to Bidders shall be completed where applicable by bidders, signed, dated and returned with the bid documents.

5. Completion of Bid Documents

Bidders will only be considered on receipt of this bid document correctly completed with all insertions in black ink.

Bidders are required to complete and sign, where applicable, all forms to be completed by bidder.

Bidders are required to indicate the detail of their offer at the space provided in the **PRICING SCHEDULE (ECBD 3.1) on page 67 and Contract Form (ECBD 7.1) on page 58** included in this document.

No unauthorized alteration shall be made to the document. Mistakes made by the bidder in the completion of the **SERVICES PARTICULAR SPECIFICATIONS OR PRICING SCHEDULE**, forms, etc. shall not be erased nor erasing fluid used. A line shall be drawn through the incorrect entry and the correct entry shall be written above and the correction initialed by the bidder.

All information is to be provided on the forms provided in Bid Document. Should the provided space be insufficient, additional information should be attached to the back of the appropriate forms.

Failure to comply with any of the foregoing clauses may invalidate the bid.

Bids may also be rejected if they show any additional items not originally included in the bid documents, irregularities of any kind in either the bid form or other documents, or if the amounts tendered in the bid form are obviously unbalanced and the bidder, after having been called upon to adjust same in a reasonable manner, **fails to do so within a period of seven days of having received notification to that effect.**

6. Signing of Bids

The bid must be signed by a person duly authorized to do so. In the case of a bid being submitted on behalf of a Company, Close Corporation, Partnership or Joint Venture, such bid shall be accompanied by a certified copy of a resolution of the Board of Directors of such Company, Close Corporation or other suitable authority in the case of a Partnership or Joint Venture, in terms of which the nominee is authorised to sign on behalf of the business entity.

A bid submitted by a corporation must bear the seal of the corporation and be attested by its CEO. Bidders submitted by joint ventures of two or more firms must be accompanied by the document of formation of the joint venture, authenticated by a notary public or other official deputed to witness sworn statements, in which is defined precisely the conditions under which the joint venture will function, its period of duration, the persons authorized to represent and obligate it, the participation of the several firms forming the joint venture, and any other information necessary to permit a full appraisal of its functioning.

The joint venture documentation is also to clearly state that all its parties will remain severally and jointly bound for the duration of the defects liability period, as well as setting out how matters will be dealt with that may arise as latent defects once the joint venture has dissolved. If due to any unforeseen reasons the joint venture dissolves during the defects liability period, the agreement must clearly state how the liability will be dealt with in terms of honoring all the responsibilities it may still have with regards to the due performance of all contractual issues that could arise.

7. ALLOWANCE FOR CONTRACT PRICE ADJUSTMENT

There will be **no allowance for Contract Price Adjustment.**

8. SCHEDULE OF QUANTITIES

Bidders shall note that all quantities in the schedule are provisional and substantial alterations to individual quantities could occur.

Should the bidder be in doubt as to the description of any items, or the meaning of any measurement or payment clause, clarification shall be obtained in writing from the Chief Engineer and this correspondence shall be submitted with the bid.

The Chief Engineer will not consider claims submitted on the basis of misunderstanding of or omissions from the description of scheduled items or measurement or payment clauses.

9. BID ALL INCLUSIVE

Bidders shall allow in their bid for all costs of supply, delivery to the site and warranty in accordance with the bid documents. Bidders shall also allow for the payment and recovery of all taxes, levies and other duties. No claims for additional payment in this respect will be considered.

Prices and rates tendered in the schedule of quantities shall be exclusive of Value Added Tax (VAT). VAT shall be added in the summary and the total price shall be inclusive of VAT.

10. PERIOD OF VALIDITY OF BIDS

The period of validity of bids shall be **90 days** from the closing date for submission of bids.

Should the bidder withdraw or retract his bid within the period of validity, or should the bidder fail to take up the Contract when notified in accordance with the General Conditions of Contract, or fail to furnish approved sureties or insurances within the period specified, then he shall pay either the difference between his bid and a less favourable bid accepted, or if the Employer decides to invite fresh bids, all additional expenses which the Employer has to incur in this regard, as well as any difference between his bid and the accepted new bid. The Employer may, however, fully or partly exempt a bidder from the provisions of this sub rule if he is of the opinion that the circumstances justify the exemption.

11. EVIDENCE OF SUPPLIERS / CONTRACTORS / CONSULTANTS EXPERIENCE

Bidders shall fill in details of goods and services supplied or work previously and successfully executed by them of a similar nature to that for which this bid is being submitted in the Form provided in this document. In the case of joint ventures or consortiums, the work experience of each firm is to be submitted.

Failure to provide this information may deem the bid as being submitted by an inexperienced bidder and it may be rejected for such reason. If the Bidder having been called upon to provide information in a reasonable manner, **fails to do so within a period of seven (7) days of having received notification to that effect.**

12. INSURANCES

In accordance with Clause 7 of the General Conditions of Contract and Special conditions of Contract, the successful bidder will be required to provide to the satisfaction of the employer a copy of the insurance documentation showing that the insurance policies required in terms of the General Conditions of Contract have been taken out and provide proof of payment of the premiums for the insurances required.

13. DECLARATION OF GOOD STANDING REGARDING TAX

Bidders are not required to submit an original Tax Clearance Certificate with their bid as this will be verified on CSD.

14. DECLARATION OF GOOD STANDING REGARDING B-BBEE LEVEL STATUS

Bidders are required to submit a B-BBEE Status Level Certificate or a Sworn Affidavit with their bid. Only Certificates that shows the SANAS Logo or a signed sworn affidavit by a Commissioner of Oath is acceptable.

15. FINANCIAL INVESTIGATION

The Employer reserves the right to appoint an accountant to report on the financial resources of any bidder. The bidder shall provide all reasonable help in such investigation and ensure that the necessary documentation is provided within seven days of being called upon to do so.

16. AMENDMENTS TO BID BY EMPLOYER

16.1 Arithmetical Errors

The Employer reserves the right to correct arithmetical or other errors in the extension of rates and totals in the bid. The bidder will be informed about the effect of any corrections on his bid sum prior to acceptance of the bid. **In no case will the BID SUM be adjusted when such errors are corrected.**

16.2 Imbalance in Tender Rates

In the event of there being any rate or rates which are declared to be unacceptable by the Employer for reasons which the Employer will indicate, the bidder will be requested -

- (a) to justify any specific rate or rates, i.e. to give a financial breakdown of how such rate or rates were obtained,
- (b) and subsequently to consider amending and adjusting such rate or rates while retaining the bid sum derived under sub-clause 15.1 unchanged and fixed. It must be understood that in the event of the **bidder refusing to adjust any rate or rates to the satisfaction of the Employer, such refusal may prejudice his bid.**

17. COST OF BID

Any expenses or losses, which may be incurred by the bidders in the preparation and submission of their bids, shall be for the account of the bidders.

18. DISQUALIFICATION OF BID

The bid of any bidder who has not conformed to these Bid Rules and the instructions reflected in the official Bid Notice or pricing instruction may be disqualified at the discretion of the Employer.

19. DELEGATION OF AUTHORITY BY EMPLOYER

The Employer may delegate any power vested in him by virtue of these Bid Rules to an officer or employee of the Employer.

20. BID RULES ARE BINDING

The bid rules as well as the instructions given in the official Bid Notice, Scope of works and Pricing Instruction, shall be binding on all bidders submitting bids for the services stated in the bid documents.

21. BID ACCEPTANCE

The Employer does not bind himself to accept the lowest or any bid. The Employer may award different items to different bidders.

22. ADJUDICATION OF BIDS

22.1 Bidders Qualifying for Adjudication

Only bidders meeting the following requirements will be eligible for adjudication in terms of the preference point system:

- (i) Bidder has complied with all the bid rules.
- (ii) The tender offer is signed by a person authorized to sign on behalf of the Tenderer;
- (iii) The Tenderer or a competent authorised representative of the Service provider/ Consultant/Contractor who submitted the tender has attended the compulsory clarification meeting and site verification inspection;
- (iv) Bidder has compiled all the declarations. (ECBD 4, 6.1, 6.2, 8 and 9);
- (v) The Tenderer or any of its directors is not listed on the Register of Tender Defaulters in terms of the Prevention and Combating of Corrupt Activities Act of 2004 as a person prohibited from doing business with the public sector;
- (vi) The Tenderer has not:
 - abused the Employer's Supply Chain Management System;
 - or failed to perform on any previous contract and has been given a written notice to this effect;
- (vii) Bidder has adequate resources available with regards to financial resources and personnel;
- (viii) The Bidder has completed the Compulsory Enterprise Questionnaire and there are no conflicts of interest which may impact on the tenderer's ability to perform the contract in the best interests of the employer or potentially compromise the tender process;
- (ix) Having completed and attached the agreement form with a manufacturer / supplier / importer / contractor to deal, repair equipment and execute services.

- (x) Having submitted a balanced bid with respect to unit rates and sums.
- (xi) Any bidder from **outside the Province, must sub-contract a minimum of 25% of the work contract value to a nominated Local Service provider. The bidder must procure input materials from Local Suppliers where possible and appoint unskilled labour from within the locality of the project if labour is needed.** Proof of the preferred sub-contractors must be attached to the bid and nominated in ECBD 6.1 paragraph 7.

In order to ensure that the procurement point allocation for the financial components is not distorted by unreasonably low prices and to protect the integrity of the process, only bids that is considered to be reasonable, will be evaluated.

22.2 Procurement Points System

Bids will be adjudicated using the 80/20 or 90/10 point's formula

- the 80/20 system for requirements with a Rand value of up to R 50 000 000 (all applicable taxes included); and
- the 90/10 system for requirements with a Rand value above R 50 000 000 (all applicable taxes included).

22.3 Financial Components

Max 80 points (80/20 formula)
Max 90 points (90/10 formula)

The points scored for the financial component will be calculated using the formula as set out in ECBD 6.1

22.4 B-BBEE Certificate of Accreditation

Max 20 points (80/20 formula)
Max 10 points (90/10 formula)

Points as allocated on the B-BBEE Certificate submitted and as per prescribed regulations indicated in paragraph 5 as set out in ECBD 6.1.

B-BBEE Status Level of Contributor	Number of points (90/10 system)	Number of points (80/20 system)
1	10	20
2	9	18
3	6	14
4	5	12
5	4	8
6	3	6
7	2	4
8	1	2
Non-compliant contributor	0	0

22.5 Local Content

Bidders must ensure adherence to **the Local Content threshold of 100% for all steel products and components for construction.** Non-compliance with this minimum threshold will render the bid non-responsive.

23. PROJECT COMPLETION TIME FRAME

The Bidder shall complete the works within 2 months (60 days) after the receipt of order.

24. PENALTY

The Bidder's attention is drawn to the forms which contain a declaration statement.

The Employer reserves the right to take legal action against bidders who tendered information that are later found to be incorrect.

If the Bidder fails to deliver any Services/works within the period specified in the contract, or within any extension thereof granted by the Employer, the purchaser shall, without prejudice to its other remedies under the contract, deduct from the contract price, as a penalty, a sum calculated on the delivered price of the delayed goods or unperformed services using the current prime interest rate calculated for each day of the delay until actual delivery or performance. The purchaser may also consider termination of the contract pursuant to GCC Clause 23.

25. LEGAL ASPECTS

If, after the date of the Contract Agreement, the cost or duration of the services is altered as a result of changes in, or additions to any statute, regulation or by-law, or in the requirements of any authority having jurisdiction over any matter in respect of the Contract, then the agreed remuneration and time for completion shall be adjusted in order to reflect the impact of those changes.

PART 2 RETURNABLE DOCUMENTS

2.1

List of Returnable Documents

EASTERN CAPE PROVINCIAL GOVERNMENT

DEPARTMENT OF RURAL DEVELOPMENT AND AGRARIAN REFORM

BID DOCUMENT FOR THE SUPPLY AND DELIVERY OF FENCING MATERIAL TO FARMS IN ENOCH MGIJIMA LOCAL MUNICIPALITY OF THE CHRIS HANI DISTRICT IN THE EASTERN CAPE PROVINCE.

2.1 List of Returnable Documents

The tenderer must complete the following returnable documents:

1 Returnable Schedules required only for tender evaluation purposes

- Certificate of authority for joint ventures (where applicable)
- Compulsory Enterprise Questionnaire
- Record of Addenda to Tender Documents
- Schedule of the Tenderer's Experience

2 Other documents required only for tender evaluation purposes

- Proof of registration on the CSD and copy of active and updated certificate attached.
- Certificate of B-BBEE Registration with level of contribution.

3 Returnable Schedules that will be incorporated into the contract

- Preferencing Schedule ECBD 6.1
- Declaration Certificate for Local Production and Content for Designated Sectors ECBD 6.2

4 Other documents that will be incorporated into the contract

- Declaration of validity of information.
- Declaration of Interest - ECBD 4.
- Declaration of tenderer's past SCM practices - ECBD 8.
- Certification of independent tender determination - ECBD 9.
- Certificate of tenderer's visit to clarification/site meeting.
- Tenderer's Banking detail confirmation.
- Surety and Bank details (if needed).
- Certificate: Confirmation of supply arrangements between the bidder and his/her supplier

5 The offer portion of the C1.1 Offer and Acceptance

6 Bills of quantities

Certificate of Authority for Joint Ventures

This Returnable Schedule is to be completed by joint ventures.

We, the undersigned, are submitting this tender offer in Joint Venture and hereby authorise Mr/Ms _____ authorised signatory of the company _____, acting in the capacity of lead partner, to sign all documents in connection with the tender offer and any contract resulting from it on our behalf.

NAME OF FIRM	ADDRESS	DULY AUTHORISED SIGNATORY
Lead partner		Signature. Name. Designation.
		Signature. Name. Designation.
		Signature. Name. Designation.
		Signature. Name. Designation.

Compulsory Enterprise Questionnaire

The following particulars must be furnished. In the case of a joint venture, **separate** enterprise questionnaires in respect of each partner must be completed and submitted.

Section 1: Name of enterprise:

Section 2: VAT registration number, if any:

Section 3: CIDB registration number, if any:

Section 4: Particulars of sole proprietors and partners in partnerships

Name*	Identity number*	Personal income tax number*

* Complete only if sole proprietor or partnership and attach separate page if more than 3 partners

Section 5: Particulars of companies and close corporations

Company registration number.

Close corporation number.

Tax reference number.

Section 6: Record in the service of the state

Indicate by marking the relevant boxes with a cross, if any sole proprietor, partner in a partnership or director, manager, principal shareholder or stakeholder in a company or close corporation is currently or has been within the last 12 months in the service of any of the following:

- | | |
|--|---|
| <input type="checkbox"/> a member of any municipal council
<input type="checkbox"/> a member of any provincial legislature
<input type="checkbox"/> a member of the National Assembly or the National Council of Province
<input type="checkbox"/> a member of the board of directors of any municipal entity
<input type="checkbox"/> an official of any municipality or municipal entity | <input type="checkbox"/> an employee of any provincial department, national or provincial public entity or constitutional institution within the meaning of the Public Finance Management Act, 1999 (Act 1 of 1999)
<input type="checkbox"/> a member of an accounting authority of any national or provincial public entity
<input type="checkbox"/> an employee of Parliament or a provincial legislature |
|--|---|

If any of the above boxes are marked, disclose the following:

Name of sole proprietor, partner, director, manager, principal shareholder or stakeholder	Name of institution, public office, board or organ of state and position held	Status of service (tick appropriate column)	
		Current	Within last 12 months

*insert separate page if necessary

Section 7: Record of spouses, children and parents in the service of the state

Indicate by marking the relevant boxes with a cross, if any spouse, child or parent of a sole proprietor, partner in a partnership or director, manager, principal shareholder or stakeholder in a company or close corporation is currently or has been within the last 12 months been in the service of any of the following:

- | | |
|--|---|
| <input type="checkbox"/> a member of any municipal council | <input type="checkbox"/> an employee of any provincial department, national or provincial public entity or constitutional institution within the meaning of the Public Finance Management Act, 1999 (Act 1 of 1999) |
| <input type="checkbox"/> a member of any provincial legislature | <input type="checkbox"/> a member of an accounting authority of any national or provincial public entity |
| <input type="checkbox"/> a member of the National Assembly or the National Council of Province | <input type="checkbox"/> an employee of Parliament or a provincial legislature |
| <input type="checkbox"/> a member of the board of directors of any municipal entity | |
| <input type="checkbox"/> an official of any municipality or municipal entity | |

Name of spouse, child or parent	Name of institution, public office, board or organ of state and position held	Status of service (tick appropriate column)	
		Current	Within last 12 months

*insert separate page if necessary

The undersigned, who warrants that he / she is duly authorised to do so on behalf of the enterprise:

- i) authorizes the Employer to obtain a tax clearance certificate from the South African Revenue Services that my / our tax matters are in order;
- ii) confirms that the neither the name of the enterprise or the name of any partner, manager, director or other person, who wholly or partly exercises, or may exercise, control over the enterprise appears on the Register of Tender Defaulters established in terms of the Prevention and Combating of Corrupt Activities Act of 2004;
- iii) confirms that no partner, member, director or other person, who wholly or partly exercises, or may exercise, control over the enterprise appears, has within the last five years been convicted of fraud or corruption;
- iv) confirms that I / we are not associated, linked or involved with any other tendering entities submitting tender offers and have no other relationship with any of the tenderers or those responsible for compiling the scope of work that could cause or be interpreted as a conflict of interest; and
- v) confirms that the contents of this questionnaire are within my personal knowledge and are to the best of my belief both true and correct.

Signed _____ Date _____

Name _____ Position _____

Enterprise name _____

Record of Addenda to tender documents

We confirm that the following communications received from the Employer before the submission of this tender offer, amending the tender documents, have been taken into account in this tender offer:

	Date	Title or Details
1.		
2.		
3.		
4.		
5.		
6.		
7.		
8.		

Attach additional pages if more space is required.

Signed

Date

Name

Position

Tenderer

Proposed amendments and qualifications

The Tenderer should record any deviations or qualifications he may wish to make to the tender documents in this Returnable Schedule. Alternatively, a tenderer may state such deviations and qualifications in a covering letter to his tender and reference such letter in this schedule.

The Tenderer's attention is drawn to clause C.3.8 of the Standard Conditions of Tender referenced in the Tender Data regarding the employer's handling of material deviations and qualifications.

Page	Clause or item	Proposal

Signed

Date

Name

Position

Tenderer

Schedule of The Tenderer's Experience: Completed Projects

The following is a statement of similar work successfully executed by myself / ourselves over the past five (5) years:

Employer, contact person and telephone number.	Description of contract	Value of work inclusive of VAT (Rand)	Date contract started	Date contract completed

Signed

Date

Name

Position

Tenderer

Schedule of The Tenderer’s Experience: – Current Projects

Tenderers must submit a max of one-page description of projects under execution/ on hold/ or just awarded/ or towards completion (if they exist). **Attach an Appointment letter for each of the projects provided.**

The description of each project must include the following information:

1. Essential introductory information:
 - 1.1 Name of project.
 - 1.2 Name of client.
 - 1.3 Contact details of client. (including telephone numbers and email addresses) of currently contactable references.
 - 1.4 The period during which the project was performed, and also, if this is different.
 - 1.5 Cost of supply and delivery and/or contract value (making it clear in broad terms what this cost/value purchased, and to what extent (if any) this cost/value was part of a larger project).

NO.	NAME OF PROJECT.	NAME OF CLIENT.	CONTACT DETAILS OF CLIENT.	PROJECT VALUE	STAGE OF PROJECT
1					
2					
3					

The undersigned, who warrants that she/ he is duly authorised to do so on behalf of the enterprise, confirms that the content of this schedule that presented by the tenderer are within my personal knowledge and are to the best of my knowledge both true and correct.

SIGNATURE OF TENDERER:
(of person authorised to sign on behalf of the Tenderer)

DATE:

Contractors Certificate of registration on CSD

[The tenderer shall submit the Contractor's Certificate of Registration on the CSD. Failure to submit the certificate with the tender document will lead to the conclusion that the tenderer is not registered on the National Treasury Central Suppliers Database and therefore not eligible to tender].

PREFERENCE POINTS CLAIM FORM IN TERMS OF THE PREFERENTIAL PROCUREMENT REGULATIONS 2017

This preference form must form part of all bids invited. It contains general information and serves as a claim form for preference points for Broad-Based Black Economic Empowerment (B-BBEE) Status Level of Contribution

NB: BEFORE COMPLETING THIS FORM, BIDDERS MUST STUDY THE GENERAL CONDITIONS, DEFINITIONS AND DIRECTIVES APPLICABLE IN RESPECT OF B-BBEE, AS PRESCRIBED IN THE PREFERENTIAL PROCUREMENT REGULATIONS, 2017.

1. GENERAL CONDITIONS

1.1 The following preference point systems are applicable to all bids:

- the 80/20 system for requirements with a Rand value of up to R 50 000 000 (all applicable taxes included); and
- the 90/10 system for requirements with a Rand value above R 50 000 000 (all applicable taxes included).

1.2

- a) The value of this bid is estimated to not exceed R 50 000 000 (all applicable taxes included) and therefore the **80/20** preference point system shall be applicable; or
- b) Either the 80/20 or 90/10 preference point system will be applicable to this tender (*delete whichever is not applicable for this tender*).

1.3 Points for this bid shall be awarded for:

- (a) Price; and
- (b) B-BBEE Status Level of Contributor.

1.4 The maximum points for this bid are allocated as follows:

	POINTS
PRICE	80
B-BBEE STATUS LEVEL OF CONTRIBUTOR	20
Total points for Price and B-BBEE must not exceed	100

1.5 Failure on the part of a bidder to submit proof of B-BBEE Status level of contributor together with the bid, will be interpreted to mean that preference points for B-BBEE status level of contribution are not claimed.

1.6 The purchaser reserves the right to require of a bidder, either before a bid is adjudicated or at any time subsequently, to substantiate any claim in regard to preferences, in any manner required by the purchaser.

2. DEFINITIONS

- (a) “**B-BBEE**” means broad-based black economic empowerment as defined in section 1 of the Broad-Based Black Economic Empowerment Act;
- (b) “**B-BBEE status level of contributor**” means the B-BBEE status of an entity in terms of a code of good practice on black economic empowerment, issued in terms of section 9(1) of the Broad-Based Black Economic Empowerment Act;
- (c) “**bid**” means a written offer in a prescribed or stipulated form in response to an invitation by an organ of state for the provision of goods or services, through price quotations, advertised competitive bidding processes or proposals;
- (d) “**Broad-Based Black Economic Empowerment Act**” means the Broad-Based Black Economic Empowerment Act, 2003 (Act No. 53 of 2003);
- (e) “**EME**” means an Exempted Micro Enterprise in terms of a code of good practice on black economic empowerment issued in terms of section 9 (1) of the Broad-Based Black Economic Empowerment Act;
- (f) “**functionality**” means the ability of a tenderer to provide goods or services in accordance with specifications as set out in the tender documents.
- (g) “**prices**” includes all applicable taxes less all unconditional discounts;
- (h) “**proof of B-BBEE status level of contributor**” means:
 - 1) B-BBEE Status level certificate issued by an authorized body or person;
 - 2) A sworn affidavit as prescribed by the B-BBEE Codes of Good Practice;
 - 3) Any other requirement prescribed in terms of the B-BBEE Act;
- (i) “**QSE**” means a qualifying small business enterprise in terms of a code of good practice on black economic empowerment issued in terms of section 9 (1) of the Broad-Based Black Economic Empowerment Act;
- (j) “**rand value**” means the total estimated value of a contract in Rand, calculated at the time of bid invitation, and includes all applicable taxes;

3. POINTS AWARDED FOR PRICE

3.1 THE 80/20 OR 90/10 PREFERENCE POINT SYSTEMS

A maximum of 80 or 90 points is allocated for price on the following basis:

$$P_s = 80 \left(1 - \frac{P_t - P_{\min}}{P_{\min}} \right) \quad \text{or} \quad P_s = 90 \left(1 - \frac{P_t - P_{\min}}{P_{\min}} \right)$$

Where

- P_s = Points scored for price of bid under consideration
- P_t = Price of bid under consideration
- P_{\min} = Price of lowest acceptable bid

4. POINTS AWARDED FOR B-BBEE STATUS LEVEL OF CONTRIBUTOR

4.1 In terms of Regulation 6 (2) and 7 (2) of the Preferential Procurement Regulations, preference points must be awarded to a bidder for attaining the B-BBEE status level of contribution in accordance with the table below:

B-BBEE Status Level of Contributor	Number of points (90/10 system)	Number of points (80/20 system)
1	10	20
2	9	18
3	6	14
4	5	12
5	4	8
6	3	6
7	2	4
8	1	2
Non-compliant contributor	0	0

5. BID DECLARATION

5.1 Bidders who claim points in respect of B-BBEE Status Level of Contribution must complete the following:

6. B-BBEE STATUS LEVEL OF CONTRIBUTOR CLAIMED IN TERMS OF PARAGRAPHS 1.4 AND 4.1

6.1 B-BBEE Status Level of Contributor: = (maximum of 10 or 20 points)

(Points claimed in respect of paragraph 7.1 must be in accordance with the table reflected in paragraph 4.1 and must be substantiated by relevant proof of B-BBEE status level of contributor.)

7. SUB-CONTRACTING

7.1 Will any portion of the contract be sub-contracted?

(Tick applicable box)

YES	<input type="checkbox"/>	NO	<input type="checkbox"/>
-----	--------------------------	----	--------------------------

7.1.1 If yes, indicate:

i) What percentage of the contract will be subcontracted%

ii) The name of the sub-contractor

iii) The B-BBEE status level of the sub-contractor

iv) Whether the sub-contractor is an EME or QSE

(Tick applicable box)

YES	<input type="checkbox"/>	NO	<input type="checkbox"/>
-----	--------------------------	----	--------------------------

v) Specify, by ticking the appropriate box, if subcontracting with an enterprise in terms of Preferential Procurement Regulations, 2017:

Designated Group: An EME or QSE which is at least 51% owned by:	EME	QSE
	√	√
Black people		
Black people who are youth		
Black people who are women		
Black people with disabilities		
Black people living in rural or underdeveloped areas or townships		
Cooperative owned by black people		
Black people who are military veterans		
OR		
Any EME		
Any QSE		

8. DECLARATION WITH REGARD TO COMPANY/FIRM

8.1 Name of company/firm:

8.2 VAT registration number:

8.3 Company registration number:

8.4 TYPE OF COMPANY/ FIRM

- Partnership/Joint Venture / Consortium
 - One-person business/sole propriety
 - Close corporation
 - Company
 - (Pty) Limited
- [TICK APPLICABLE BOX]

8.5 DESCRIBE PRINCIPAL BUSINESS ACTIVITIES

.....
.....
.....

8.6 COMPANY CLASSIFICATION

- Manufacturer
 - Supplier
 - Professional service provider
 - Other service providers, e.g. transporter, etc.
- [TICK APPLICABLE BOX]

8.7 Total number of years the company/firm has been in business:

8.8 I/we, the undersigned, who is / are duly authorised to do so on behalf of the company/firm, certify that the points claimed, based on the B-BBE status level of contributor indicated in paragraphs 1.4 and 6.1 of the foregoing certificate, qualifies the company/ firm for the preference(s) shown and I / we acknowledge that:

- i) The information furnished is true and correct;
- ii) The preference points claimed are in accordance with the General Conditions as indicated in

paragraph 1 of this form;

- iii) In the event of a contract being awarded as a result of points claimed as shown in paragraphs 1.4 and 6.1, the contractor may be required to furnish documentary proof to the satisfaction of the purchaser that the claims are correct;
- iv) If the B-BBEE status level of contributor has been claimed or obtained on a fraudulent basis or any of the conditions of contract have not been fulfilled, the purchaser may, in addition to any other remedy it may have –
 - (a) disqualify the person from the bidding process;
 - (b) recover costs, losses or damages it has incurred or suffered as a result of that person's conduct;
 - (c) cancel the contract and claim any damages which it has suffered as a result of having to make less favourable arrangements due to such cancellation;
 - (d) recommend that the bidder or contractor, its shareholders and directors, or only the shareholders and directors who acted on a fraudulent basis, be restricted by the National Treasury from obtaining business from any organ of state for a period not exceeding 10 years, after the *audi alteram partem* (hear the other side) rule has been applied; and
 - (e) forward the matter for criminal prosecution.

<p>WITNESSES</p> <p>1.</p> <p>2.</p>
--

<p>..... SIGNATURE(S) OF BIDDERS(S)</p> <p>DATE:</p> <p>ADDRESS</p> <p>.....</p> <p>.....</p>

SWORN AFFIDAVIT – B-BBEE EXEMPTED MICRO ENTERPRISE - GENERAL

I, the undersigned,

Full name & Surname	
Identity number	

Hereby declare under oath as follows:

1. The contents of this statement are to the best of my knowledge a true reflection of the facts.

2. I am a Member / Director / Owner of the following enterprise and am duly authorised to act on its behalf:

Enterprise Name:	
Trading Name (If Applicable):	
Registration Number:	
Enterprise Physical Address:	
Type of Entity (CC, (Pty) Ltd, Sole Prop etc.):	
Nature of Business:	
Definition of “Black People”	<p>As per the Broad-Based Black Economic Empowerment Act 53 of 2003 as Amended by Act No 46 of 2013 “Black People” is a generic term which means Africans, Coloureds and Indians –</p> <ul style="list-style-type: none"> (a) who are citizens of the Republic of South Africa by birth or descent; or (b) who became citizens of the Republic of South Africa by naturalisation- <ul style="list-style-type: none"> i. before 27 April 1994; or ii. on or after 27 April 1994 and who would have been entitled to acquire citizenship by naturalization prior to that date;”
Definition of “Black Designated Groups”	<p>“Black Designated Groups means:</p> <ul style="list-style-type: none"> (a) unemployed black people not attending and not required by law to attend an educational institution and not awaiting admission to an educational institution; (b) Black people who are youth as defined in the National Youth Commission Act of 1996; (c) Black people who are persons with disabilities as defined in the Code of Good Practice on employment of people with disabilities issued under the Employment Equity Act; (d) Black people living in rural and under developed areas; (e) Black military veterans who qualifies to be called a military veteran in terms of the Military Veterans Act 18 of 2011;”

3. I hereby declare under Oath that:

- The Enterprise is _____% Black Owned as per Amended Code Series 100 of the Amended Codes of Good Practice issued under section 9 (1) of B-BBEE Act No 53 of 2003 as Amended by Act No 46 of 2013,
- The Enterprise is _____% Black Female Owned as per Amended Code Series 100 of the Amended Codes of Good Practice issued under section 9 (1) of B-BBEE Act No 53 of 2003 as Amended by Act No 46 of 2013,
- The Enterprise is _____% Black Designated Group Owned as per Amended Code Series 100 of the Amended Codes of Good Practice issued under section 9 (1) of B-BBEE Act No 53 of 2003 as Amended by Act No 46 of 2013,
- Black Designated Group Owned % Breakdown as per the definition stated above:
 - Black Youth % = _____%
 - Black Disabled % = _____%
 - Black Unemployed % = _____%
 - Black People living in Rural areas % = _____%
 - Black Military Veterans % = _____%
- Based on the Financial Statements/Management Accounts and other information available on the latest financial year-end of _____, the annual Total Revenue was R10,000,000.00 (Ten Million Rands) or less.
- Please Confirm on the below table the B-BBEE Level Contributor, **by ticking the applicable box.**

100% Black Owned	Level One (135% B-BBEE procurement recognition level)	
At least 51% Black Owned	Level Two (125% B-BBEE procurement recognition level)	
Less than 51% Black Owned	Level Four (100% B-BBEE procurement recognition level)	

4. I know and understand the contents of this affidavit and I have no objection to take the prescribed oath and consider the oath binding on my conscience and on the Owners of the Enterprise which I represent in this matter.
5. The sworn affidavit will be valid for a period of 12 months from the date signed by commissioner.

Deponent Signature: _____

Date: _____

Commissioner of Oaths

Signature & stamp

DECLARATION CERTIFICATE FOR LOCAL PRODUCTION AND CONTENT FOR DESIGNATED SECTORS

NB: This Standard Tender Document (SBD) must form part of all tenders invited. It contains general information and serves as a declaration form for local content (local production and local content are used interchangeably).

Before completing this declaration, bidders must study the General Conditions, Definitions, Directives applicable in respect of Local Content as prescribed in the Preferential Procurement Regulations, 2011 and the South African Bureau of Standards (SABS) approved technical specification number SATS 1286:2011 (Edition 1) and the Guidance on the Calculation of Local Content together with the Local Content Declaration Templates [Annex C (Local Content Declaration: Summary Schedule), D (Imported Content Declaration: Supporting Schedule to Annex C) and E (Local Content Declaration: Supporting Schedule to Annex C)].

1 GENERAL CONDITIONS

- 1.1. Preferential Procurement Regulations, 2011 (Regulation 9) makes provision for the promotion of local production and content.
- 1.2. Regulation 9.(1) prescribes that in the case of designated sectors, where in the award of bids local production and content is of critical importance, such bids must be advertised with the specific bidding condition that only locally produced goods, services or works or locally manufactured goods, with a stipulated minimum threshold for local production and content will be considered.
- 1.3. Where necessary, for bids referred to in paragraph 1.2 above, a two stage bidding process may be followed, where the first stage involves a minimum threshold for local production and content and the second stage price and B-BBEE.
- 1.4. A person awarded a contract in relation to a designated sector, may not sub-contract in such a manner that the local production and content of the overall value of the contract is reduced to below the stipulated minimum threshold.
- 1.5. The local content (LC) expressed as a percentage of the bid price must be calculated in accordance with the SABS approved technical specification number SATS 1286: 2011 as follows:

$$LC = [1 - x / y] * 100$$

Where

- x is the imported content in Rand
y is the bid price in Rand excluding value added tax (VAT)

Prices referred to in the determination of x must be converted to Rand (ZAR) by using the exchange rate published by the South African Reserve Bank (SARB) at 12:00 on the date of advertisement of the bid as required in paragraph 4.1 below.

The SABS approved technical specification number SATS 1286:2011 is accessible on http://www.thedti.gov.za/industrial_development/ip.jsp at no cost.

A bid may be disqualified if –

- (a) this Declaration Certificate and the Annex C (Local Content Declaration: Summary Schedule) are not submitted as part of the bid documentation; and
- (b) the bidder fails to declare that the Local Content Declaration Templates (Annex C, D and E) have been audited and certified as correct.

2. Definitions

- 2.1 **“bid”** includes written price quotations, advertised competitive bids or proposals;
- 2.2 **“bid price”** price offered by the bidder, excluding value added tax (VAT);
- 2.3 **“contract”** means the agreement that results from the acceptance of a bid by an organ of state;
- 2.4 **“designated sector”** means a sector, sub-sector or industry that has been designated by the Department of Trade and Industry in line with national development and industrial policies for local production, where only locally produced services, works or goods or locally manufactured goods meet the stipulated minimum threshold for local production and content;
- 2.5 **“duly sign”** means a Declaration Certificate for Local Content that has been signed by the Chief Financial Officer or other legally responsible person nominated in writing by the Chief Executive, or senior member / person with management responsibility (close corporation, partnership or individual).
- 2.6 **“imported content”** means that portion of the bid price represented by the cost of components, parts or materials which have been or are still to be imported (whether by the supplier or its subcontractors) and which costs are inclusive of the costs abroad (this includes labour and intellectual property costs), plus freight and other direct importation costs, such as landing costs, dock duties, import duty, sales duty or other similar tax or duty at the South African port of entry;
- 2.7 **“local content”** means that portion of the bid price which is not included in the imported content, provided that local manufacture does take place;
- 2.8 **“stipulated minimum threshold”** means that portion of local production and content as determined by the Department of Trade and Industry; and
- 2.9 **“sub-contract”** means the primary contractor’s assigning, leasing, making out work to, or employing another person to support such primary contractor in the execution of part of a project in terms of the contract.

3. The stipulated minimum threshold(s) for local production and content (refer to Annex A of SATS 1286:2011) for this bid is/are as follows:

- 3.1 The stipulated minimum threshold(s) for local production and content for this tender is/are as follows:

<u>Description of services, works or goods</u>	<u>Stipulated minimum threshold</u>
Steel Products and Components for Construction (Fencing materials, Fencing tools and Steel gates)	100%
Does any portion of the services, works or goods offered have any imported content?	YES / NO

- 4.1. If yes, the rate(s) of exchange to be used in this bid to calculate the local content as prescribed in paragraph 1.5 of the general conditions must be the rate(s) published by the SARB for the specific currency at 12:00 on the date of advertisement of the bid.

The relevant rates of exchange information are accessible on www.reservebank.co.za.

Indicate the rate(s) of exchange against the appropriate currency in the table below (refer to Annex A of SATS 1286:2011):

Currency	Rates of exchange
US Dollar	
Pound Sterling	
Euro	
Yen	
Other	

NB: Tenderers must submit proof of the SARB rate (s) of exchange used.

4. Were the Local Content Declaration Templates, (Annex C, D and E) audited and certified as correct? **YES / NO**

5.1. If yes, provide the following particulars:

- (a) Full name of auditor:
- (b) Practice number:
- (c) Telephone and cell number:
- (d) Email address:

(Documentary proof regarding the declaration will, when required, be submitted to the satisfaction of the Accounting Officer / Accounting Authority)

6. Where, after the award of a bid, challenges are experienced in meeting the stipulated minimum threshold for local content the dti must be informed accordingly in order for the dti to verify and in consultation with the Accounting Officer / Accounting Authority provide directives in this regard.

LOCAL CONTENT DECLARATION
(REFER TO ANNEX B OF SATS 1286:2011)

LOCAL CONTENT DECLARATION BY CHIEF FINANCIAL OFFICER OR OTHER LEGALLY RESPONSIBLE PERSON NOMINATED IN WRITING BY THE CHIEF EXECUTIVE OR SENIOR MEMBER/PERSON WITH MANAGEMENT RESPONSIBILITY (CLOSE CORPORATION, PARTNERSHIP OR INDIVIDUAL)

IN RESPECT OF BID NO. SCMU8 - 21/22 - 0032

ISSUED BY: (Procurement Authority/Name of Department/Departmental Entity): **DRDAR**

NB

1. The obligation to complete, duly sign and submit this declaration cannot be transferred to an external authorized representative, auditor or any other third party acting on behalf of the bidder.
2. Guidance on the Calculation of Local Content together with Local Content Declaration Templates (Annex C, D and E) is accessible on http://www.thedti.gov.za/industrial_development/ip.jsp. Bidders should first complete Declaration D. After completing Declaration D, bidders should complete Declaration E and then consolidate the information on Declaration C. Declaration C should be submitted with the bid documentation at the closing date and time of the bid in order to substantiate the declaration made in paragraph (c) below. Declarations D and E should be kept by the bidders for verification purposes for a period of at least 5 years.
 The successful bidder is required to continuously update Declarations C, D and E with the actual values for the duration of the contract.

I, the undersigned (full names),
do hereby declare, in my capacity as
of (name of bidder entity), the following:

- (a) The facts contained herein are within my own personal knowledge.
- (b) I have satisfied myself that
 - (i) the goods/services/works to be delivered in terms of the above-specified bid comply with the minimum local content requirements as specified in the bid, and as measured in terms of SATS 1286:2011; and
 - (ii) the declaration templates have been audited and certified to be correct.
- (c) The local content percentages (%) indicated below has been calculated using the formula given in clause 3 of SATS 1286:2011, the rates of exchange indicated in paragraph 4.1 above and the information contained in Declaration D and E which has been consolidated in Declaration C;

Bid price, excluding VAT (y)	R
Imported content (x), as calculated in terms of SATS 1286:2011	R
Stipulated minimum threshold for local content (paragraph 3 above)	
Local content %, as calculated in terms of SATS 1286:2011	

If the bid is for more than one product, the local content percentages for each product contained in Declaration C shall be used instead of the table above. The local content percentages for each product has been calculated using the formula given in clause 3 of SATS 1286:2011, the rates of exchange indicated in paragraph 4.1 above and the information contained in Declaration D and E.

(d) I accept that the Procurement Authority / Municipality /Municipal Entity has the right to request that the local content be verified in terms of the requirements of SATS 1286:2011.

(e) I understand that the awarding of the bid is dependent on the accuracy of the information furnished in this application. I also understand that the submission of incorrect data, or data that are not verifiable as described in SATS 1286:2011, may result in the Procurement Authority / Municipal / Municipal Entity imposing any or all of the remedies as provided for in Regulation 13 of the Preferential Procurement Regulations, 2011 promulgated under the Preferential Policy Framework Act (PPPFA), 2000 (Act No. 5 of 2000).

SIGNATURE: _____ **DATE:** _____
WITNESS No. 1 _____ **DATE:** _____
WITNESS No. 2 _____ **DATE:** _____

Annex D

Imported Content Declaration - Supporting Schedule to Annex C

(D1) Tender No.		Note: VAT to be excluded from all calculations
(D2) Tender description:		
(D3) Designated Products:	Steel components and products for construction	
(D4) Tender Authority:	DRDAR	
(D5) Tendering Entity name:		
(D6) Tender Exchange Rate:	Rand <input type="text"/> EU <input type="text"/> GBP <input type="text"/>	

A. Exempted imported content

A. Exempted imported content				Calculation of imported content						Summary	
Tender item no's	Description of imported content	Local supplier	Overseas Supplier	Foreign currency value as per Commercial Invoice	Tender Exchange Rate	Local value of imports	Freight costs to port of entry	All locally incurred landing costs & duties	Total landed cost excl VAT	Tender Qty	Exempted imported value
(D7)	(D8)	(D9)	(D10)	(D11)	(D12)	(D13)	(D14)	(D15)	(D16)	(D17)	(D18)
(D19) Total exempt imported value											
This total must correspond with Annex C - C 21											

B. Imported directly by the Tenderer

B. Imported directly by the Tenderer				Calculation of imported content						Summary	
Tender item no's	Description of imported content	Unit of measure	Overseas Supplier	Foreign currency value as per Commercial Invoice	Tender Rate of Exchange	Local value of imports	Freight costs to port of entry	All locally incurred landing costs & duties	Total landed cost excl VAT	Tender Qty	Total imported value
(D20)	(D21)	(D22)	(D23)	(D24)	(D25)	(D26)	(D27)	(D28)	(D29)	(D30)	(D31)
(D32) Total imported value by tenderer											

C. Imported by a 3rd party and supplied to the

C. Imported by a 3rd party and supplied to the				Calculation of imported content						Summary	
Description of imported content	Unit of measure	Local supplier	Overseas Supplier	Foreign currency value as per Commercial Invoice	Tender Rate of Exchange	Local value of imports	Freight costs to port of entry	All locally incurred landing costs & duties	Total landed cost excl VAT	Quantity imported	Total imported value
(D33)	(D34)	(D35)	(D36)	(D37)	(D38)	(D39)	(D40)	(D41)	(D42)	(D43)	(D44)
(D45) Total imported value by 3rd party											

D. Other foreign currency payments

D. Other foreign currency payments					Calculation of foreign currency payments		Summary of payments	
Type of payment	Local supplier making the payment	Overseas beneficiary	Foreign currency value paid	Tender Rate of Exchange				
(D46)	(D47)	(D48)	(D49)	(D50)				(D51)
(D52) Total of foreign currency payments declared by tenderer and/or 3rd party								

Signature of tenderer from Annex B

Date: _____

(D53) Total of imported content & foreign currency payments - (D32), (D45) & (D52) above

This total must correspond with Annex C - C 23

Annex E

Local Content Declaration - Supporting Schedule to Annex C

(E1)	Tender No.	Note: VAT to be excluded from all calculations	
(E2)	Tender description:		
(E3)	Designated products:		Steel components and products for construction
(E4)	Tender Authority:		DRDAR
(E5)	Tendering Entity name		

Local Products (Goods, Services and Works)	Description of items purchased	Local suppliers	Value
	(E6)	(E7)	(E8)
	(E9) Total local products (Goods, Services and Works)		

(E10) **Manpower costs** (Tenderer's manpower cost)

(E11) **Factory overheads** (Rental, depreciation & amortisation, utility costs, consumables etc.)

(E12) **Administration overheads and mark-up** (Marketing, insurance, financing, interest etc.)

(E13) Total local content

This total must correspond with Annex C - C24

Signature of tenderer from Annex B

Date:

Declaration (Validity of Information Provided)

I declare that the information provided is true and correct, the signature to the tender document is duly authorised and documentary proof regarding any tendering issue will, when required, be submitted to the satisfaction of the Department of Rural Development and Agrarian Reform.

DATE SIGNATURE OF DECLARER

POSITION OF DECLARER

NAME OF COMPANY OR TENDERER

Should the tenderer have, in the opinion of the Department of Rural Development and Agrarian Reform, acted fraudulently illegally, in bad faith or in any improper manner, misrepresented itself with regard to the tender, then the Department of Rural Development and Agrarian Reform may, in its sole discretion:

- * Ignore any tenders without advising the tenderer thereof
- * Cancel the contract without prejudice to any legal rights the Department of Rural Development and Agrarian Reform may have

Should the tenderer disregard this or conduct affairs in a way that transgresses from good business practices, this could seriously impair future business relations between the Department of Rural Development and Agrarian Reform and such tenderer.

DECLARATION OF INTEREST

ECBD 4

1. Any legal person, including persons employed by the state¹, or persons having a kinship with persons employed by the state, including a blood relationship, may make an offer or offers in terms of this invitation to tender (includes an advertised competitive tender, a limited tender, a proposal or written price quotation). In view of possible allegations of favouritism, should the resulting tender, or part thereof, be awarded to persons employed by the state, or to persons connected with or related to them, it is required that the tenderer or his/her authorised representative declare his/her position in relation to the evaluating/adjudicating authority where-
- the tenderer is employed by the state; and/or
 - the legal person on whose behalf the tender document is signed, has a relationship with persons/a person who are/is involved in the evaluation and or adjudication of the tender(s), or where it is known that such a relationship exists between the person or persons for or on whose behalf the declarant acts and persons who are involved with the evaluation and or adjudication of the tender.

2. **In order to give effect to the above, the following questionnaire must be completed and submitted with the tender.**

- 2.1 Full Name of tenderer or his or her representative:
- 2.2 Identity Number:
- 2.3 Position occupied in the Company (director, trustee, shareholder², member):
- 2.4 Registration number of company, enterprise, close corporation, partnership agreement or trust:
- 2.5 Tax Reference Number:
- 2.6 VAT Registration Number:
- 2.6.1 The names of all directors / trustees / shareholders / members, their individual identity numbers, tax reference numbers and, if applicable, employee / PERSAL numbers must be indicated in paragraph 3 below.

¹“State” means –
(a) any national or provincial department, national or provincial public entity or constitutional institution within the meaning of the Public Finance Management Act, 1999 (Act No. 1 of 1999);
(b) any municipality or municipal entity;
(c) provincial legislature;
(d) national Assembly or the national Council of provinces; or
(e) Parliament.

²“Shareholder” means a person who owns shares in the company and is actively involved in the management of the enterprise or business and exercises control over the enterprise.

2.7 Are you or any person connected with the tenderer presently employed by the state? **YES / NO**

2.7.1 If so, furnish the following particulars:

Name of person / director / trustee / shareholder/ member:,.....

Name of state institution at which you or the person connected to the tenderer is employed:

Position occupied in the state institution:

Any other particulars:
.....
.....
.....

2.7.2 If you are presently employed by the state, did you obtain the appropriate authority to undertake remunerative work outside employment in the public sector? **YES / NO**

2.7.2.1 If yes, did you attach proof of such authority to the tender document? **YES / NO**

(Note: Failure to submit proof of such authority, where applicable, may result in the disqualification of the tender.

2.7.2.2 If no, furnish reasons for non-submission of such proof:
.....
.....
.....

2.8 Did you or your spouse, or any of the company's directors / trustees / shareholders / members or their spouses conduct business with the state in the previous twelve months? **YES / NO**

2.8.1 If so, furnish particulars:
.....
.....
.....

2.9 Do you, or any person connected with the tenderer, have any relationship (family, friend, other) with a person employed by the state and who may be involved with the evaluation and or adjudication of this tender? **YES / NO**

2.9.1 If so, furnish particulars.
.....
.....
.....

2.10 Are you, or any person connected with the tenderer, aware of any relationship (family, friend, other) between any other tenderer and any person employed by the state who may be involved with the evaluation and or adjudication of this tender? **YES / NO**

2.10.1 If so, furnish particulars.
.....
.....
.....

2.11 Do you or any of the directors / trustees / shareholders / members of the company have any interest in any other related companies whether or not they are tendering for this contract? **YES / NO**

2.11.1 If so, furnish particulars:
.....
.....

DECLARATION OF TENDERER PAST SCM PRACTICES

ECBD 8

1. This Standard Tender Document must form part of all tenders invited.
2. It serves as a declaration to be used by institutions in ensuring that when goods and services are being procured, all reasonable steps are taken to combat the abuse of the supply chain management system.
3. The tender of any tenderer may be disregarded if that tenderer, or any of its directors have: -
 - a. abused the institution's supply chain management system;
 - b. committed fraud or any other improper conduct in relation to such system; or
 - c. failed to perform on any previous contract.
4. **In order to give effect to the above, the following questionnaire must be completed and submitted with the tender.**

Item	Question	Yes <input type="checkbox"/>	No <input type="checkbox"/>
4.1	<p>Is the tenderer or any of its directors listed on the National Treasury's database as companies or persons prohibited from doing business with the public sector? (Companies or persons who are listed on this Database were informed in writing of this restriction by the Accounting Officer/Authority of the institution that imposed the restriction after the <i>audi alteram partem</i> rule was applied).</p> <p>The Database of Restricted Suppliers now resides on the National Treasury's website (www.treasury.gov.za) and can be accessed by clicking on its link at the bottom of the home page.</p>	Yes <input type="checkbox"/>	No <input type="checkbox"/>
4.1.1	If so, furnish particulars:		
4.2	<p>Is the tenderer or any of its directors listed on the Register for Tender Defaulters in terms of section 29 of the Prevention and Combating of Corrupt Activities Act (No 12 of 2004)? The Register for Tender Defaulters can be accessed on the National Treasury's website (www.treasury.gov.za) by clicking on its link at the bottom of the home page.</p>	Yes <input type="checkbox"/>	No <input type="checkbox"/>
4.2.1	If so furnish particulars:		
4.3	Was the tenderer or any of its directors convicted by a court of law (including a court outside of the Republic of South Africa) for fraud or corruption during the past five years?	Yes <input type="checkbox"/>	No <input type="checkbox"/>
4.3.1	If so, furnish particulars:		
4.4	Was any contract between the tenderer and any organ of state terminated during the past five years on account of failure to perform on or comply with the contract?	Yes <input type="checkbox"/>	No <input type="checkbox"/>
4.4.1	If so, furnish particulars:		

CERTIFICATION

I, THE UNDERSIGNED (FULL NAME)
CERTIFY THAT THE INFORMATION FURNISHED ON THIS DECLARATION FORM IS TRUE AND
CORRECT.

I ACCEPT THAT, IN ADDITION TO CANCELLATION OF A CONTRACT, ACTION MAY BE TAKEN
AGAINST ME SHOULD THIS DECLARATION PROVE TO BE FALSE.

.....
Signature

.....
Date

.....
Position

.....
Name of Tenderer

CERTIFICATE OF INDEPENDENT TENDER DETERMINATION

- 1 This Standard Tender Document (STD) must form part of all tenders¹ invited.
- 2 Section 4 (1) (b) (iii) of the Competition Act No. 89 of 1998, as amended, prohibits an agreement between, or concerted practice by, firms, or a decision by an association of firms, if it is between parties in a horizontal relationship and if it involves collusive tendering (or tender rigging).² Collusive tendering is a *per se* prohibition meaning that it cannot be justified under any grounds.
- 3 Treasury Regulation 16A9 prescribes that accounting officers and accounting authorities must take all reasonable steps to prevent abuse of the supply chain management system and authorizes accounting officers and accounting authorities to:
 - a. disregard the tender of any tenderer if that tenderer, or any of its directors have abused the institution's supply chain management system and or committed fraud or any other improper conduct in relation to such system.
 - b. cancel a contract awarded to a supplier of goods and services if the supplier committed any corrupt or fraudulent act during the tendering process or the execution of that contract.
- 4 This STD serves as a certificate of declaration that would be used by institutions to ensure that, when tenders are considered, reasonable steps are taken to prevent any form of tender-rigging.
- 5 In order to give effect to the above, the attached Certificate of Tender Determination (ECBD 9) must be completed and submitted with the tender:

¹ Includes price quotations, advertised competitive tenders, limited tenders and proposals.

² Tender rigging (or collusive tendering) occurs when businesses, that would otherwise be expected to compete, secretly conspire to raise prices or lower the quality of goods and / or services for purchasers who wish to acquire goods and / or services through a tender process. Tender rigging is, therefore, an agreement between competitors not to compete.

CERTIFICATE OF INDEPENDENT TENDER DETERMINATION

I, the undersigned, in submitting the accompanying tender:

(Tender Number and Description)

in response to the invitation for the tender made by:

(Name of Institution)

do hereby make the following statements that I certify to be true and complete in every respect:

I certify, on behalf of: _____ that:

(Name of tenderer)

1. I have read and I understand the contents of this Certificate;
2. I understand that the accompanying tender will be disqualified if this Certificate is found not to be true and complete in every respect;
3. I am authorized by the tenderer to sign this Certificate, and to submit the accompanying tender, on behalf of the tenderer;
4. Each person whose signature appears on the accompanying tender has been authorized by the tenderer to determine the terms of, and to sign the tender, on behalf of the tenderer;
5. For the purposes of this Certificate and the accompanying tender, I understand that the word "competitor" shall include any individual or organization, other than the tenderer, whether or not affiliated with the tenderer, who:
 - (a) has been requested to submit a tender in response to this tender invitation;
 - (b) could potentially submit a tender in response to this tender invitation, based on their qualifications, abilities or experience; and
 - (c) provides the same goods and services as the tenderer and/or is in the same line of business as the tenderer
6. The tenderer has arrived at the accompanying tender independently from, and without consultation, communication, agreement or arrangement with any competitor. However, communication between partners in a joint venture or consortium³ will not be construed as collusive tendering.
7. In particular, without limiting the generality of paragraphs 6 above, there has been no consultation, communication, agreement or arrangement with any competitor regarding:
 - (a) prices;
 - (b) geographical area where product or service will be rendered (market allocation)
 - (c) methods, factors or formulas used to calculate prices;
 - (d) the intention or decision to submit or not to submit, a tender;
 - (e) the submission of a tender which does not meet the specifications and conditions of the tender;

or

 - (f) tendering with the intention not to win the tender.

8. In addition, there have been no consultations, communications, agreements or arrangements with any competitor regarding the quality, quantity, specifications and conditions or delivery particulars of the products or services to which this tender invitation relates.
9. The terms of the accompanying tender have not been, and will not be, disclosed by the tenderer, directly or indirectly, to any competitor, prior to the date and time of the official tender opening or of the awarding of the contract.
10. I am aware that, in addition and without prejudice to any other remedy provided to combat any restrictive practices related to tenders and contracts, tenders that are suspicious will be reported to the Competition Commission for investigation and possible imposition of administrative penalties in terms of section 59 of the Competition Act No 89 of 1998 and or may be reported to the National Prosecuting Authority (NPA) for criminal investigation and or may be restricted from conducting business with the public sector for a period not exceeding ten (10) years in terms of the Prevention and Combating of Corrupt Activities Act No 12 of 2004 or any other applicable legislation.

.....
Signature

.....
Date

.....
Position

.....
Name of Tenderer

LOCAL ECONOMIC DEVELOPMENT PROCUREMENT FRAMEWORK DECLARATION FORM

The Honorable Premier in his State of the Province address in 2014 made a pronouncement to the effect that 50% of Provincial procurement should be spent on goods and services which are manufactured and supplied by SMMEs and Co-operatives from within the Province.

In order for goods/services with the Eastern Cape Province as per Local Economic Development Procurement Framework.

The details of the manufactures of the goods are:

NAME OF MANUFACTURER	ITEM DESCRIPTION	LOCATION

I,.....in my capacity as
.....of

Commit in procuring/sourcing the required goods from local manufacturers within the Eastern Cape Province where available.

I accept that the Department of Rural Development and Agrarian Reform may invoke penalties as per General Conditions of Contract should I be misrepresenting the content contained herein this declaration.

.....

Signature

.....

Date

.....

Position

.....

Name of bidder

DEPARTMENT OF RURAL DEVELOPMENT AND AGRARIAN REFORM

BID DOCUMENT FOR THE SUPPLY AND DELIVERY OF FENCING MATERIAL TO FARMS IN ENOCH MGIJIMA LOCAL MUNICIPALITY OF THE CHRIS HANI DISTRICT IN THE EASTERN CAPE PROVINCE.

SUPPLY ARRANGEMENTS BETWEEN THE BIDDER AND HIS/HER SUPPLIER

CERTIFICATE: CONFIRMATION OF SUPPLY ARRANGEMENTS BETWEEN THE BIDDER AND HIS/HER SUPPLIER

NB: This certificate should be completed by the bidder’s supplier(s) and signed by both parties in full and signed in ink by the bidder and his/her supplier. All the required information should be provided. Failure to adhere to these requirements will automatically invalidate the bid.

If more than one supplier is involved, the bidder must submit separate forms, completed by each of his/her suppliers.

Only original or an original certified copy of the certificate will be accepted.

CONTRACT NO. SCMU8 - 21/22 - 0032

BID DOCUMENT FOR THE SUPPLY AND DELIVERY OF FENCING MATERIAL TO FARMS IN ENOCH MGIJIMA LOCAL MUNICIPALITY.

_____ has an agreement, (Name of Bidder Supplier(s))

with _____ (Name of Bidder)

to supply of the following items as specified in the bid should they secure a contract in this regard:

Table with 2 columns: Item No., Item Description as per Bid Number. Row 1: 1., As per Bill of Quantities in Pricing Schedule (page 69)

(N.B. list may be attached)

(To be completed by Bidder’s Supplier)

I hereby confirm that I have familiarised myself with the item(s)* /description(s) /specification(s) and the conditions of the abovementioned bid.

(*Delete whichever is not applicable)

*YES *NO

I hereby also confirm that *I am the manufacturer of the item(s) or *I am a dealer who normally keeps stock of the item(s).

(*Delete whichever is not applicable)

I also confirm that payment arrangements between the two enterprises have been agreed upon.

(*Delete whichever is not applicable)

*YES *NO

The abovementioned can be confirmed with my company at the following address:

_____ Tel number: (____) _____

_____ Cell Number: _____

_____ Fax Number: (____) _____

_____ Contact Person: _____

Address

I hereby declare that I am duly authorised in my capacity as _____ to issue this certificate, and that the agreement between the parties involved does not constitute fronting.

Signed at _____ on this _____ of _____ 20____
(Place) (Day) (Month) (Year)



To be completed by the Bidder's Supplier

To be completed by the Bidder

Signature (Bidder's Supplier)

Signature (Bidder)

Name in Print (Bidder's Supplier)

Name in Print

ID Number Bidder Supplier

ID Number Bidder

The Contract

PART C1: AGREEMENT AND CONTRACT DATA

EASTERN CAPE PROVINCIAL GOVERNMENT

DEPARTMENT OF RURAL DEVELOPMENT AND AGRARIAN REFORM

BID DOCUMENT FOR THE SUPPLY AND DELIVERY OF FENCING MATERIAL TO FARMS IN ENOCH MGIJIMA LOCAL MUNICIPALITY OF THE CHRIS HANI DISTRICT IN THE EASTERN CAPE PROVINCE.

ECBD 7.1

CONTRACT FORM - PURCHASE OF GOODS/WORKS

THIS FORM MUST BE FILLED IN DUPLICATE BY BOTH THE SUCCESSFUL BIDDER (PART 1) AND THE PURCHASER (PART 2). BOTH FORMS MUST BE SIGNED IN THE ORIGINAL SO THAT THE SUCCESSFUL BIDDER AND THE PURCHASER WOULD BE IN POSSESSION OF ORIGINALLY SIGNED CONTRACTS FOR THEIR RESPECTIVE RECORDS.

PART 1 (TO BE FILLED IN BY THE BIDDER)

1. I hereby undertake to supply all or any of the goods and/or works/services described in the attached bidding documents to (name of institution) DRDAR in accordance with the requirements and specifications stipulated in bid number **SCMU8 - 21/22 - 0032** or **BID DOCUMENT FOR THE SUPPLY AND DELIVERY OF FENCING MATERIAL TO FARMS IN ENOCH MGIJIMA LOCAL MUNICIPALITY OF THE CHRIS HANI DISTRICT.**
2. at the price/s quoted. My offer/s remain binding upon me and open for acceptance by the purchaser during the validity period indicated and calculated from the closing time of bid.
3. The following documents shall be deemed to form and be read and construed as part of this agreement:
 - (i) Bidding documents, viz
 - Invitation to bid;
 - Bid Rules;
 - Returnable Documents as requested;
 - (ii) Scope of works;
 - (iii) Pricing Data, viz
 - Pricing instructions
 - Pricing schedule(s);
 - Pricing summary;
 - Payment clause;
 - (iv) Contract Form;
 - (v) Conditions of Contract viz'
 - General Conditions of Contract; and
 - Special Conditions of Contract;
4. I confirm that I have satisfied myself as to the correctness and validity of my bid; that the price(s) and rate(s) quoted cover all the goods and/or works specified in the bidding documents; that the price(s) and rate(s) cover all my obligations and I accept that any mistakes regarding price(s) and rate(s) and calculations will be at my own risk.
5. **THE OFFERED TOTAL OF THE PRICES INCLUSIVE OF VALUE ADDED TAX IS**
.....
..... Rand (in words);
R (in figures) (or other suitable wording)
6. I accept full responsibility for the proper execution and fulfilment of all obligations and conditions devolving on me under this agreement as the principal liable for the due fulfillment of this contract.
7. I declare that I have no participation in any collusive practices with any bidder or any other person regarding this or any other bid.

8. I confirm that I am duly authorised to sign this contract.

This offer may be accepted by the employer by signing the acceptance part of this form of offer and acceptance and returning one copy of this document to the bidder before the end of the period of validity stated in the bid data, whereupon the bidder becomes the party named as the Consultant identified in the contract data.

NAME (PRINT) _____
CAPACITY _____
SIGNATURE _____
NAME OF FIRM _____
DATE _____

WITNESSES	
1	_____
2	_____
DATE:	_____

PART 2 (TO BE FILLED IN BY THE EMPLOYER)

ACCEPTANCE

1. By signing this part of this form of offer and acceptance, the employer identified below accepts the bidder's offer. In consideration thereof, the employer shall pay the consultant the amount due in accordance with the conditions of contract identified in the contract data. Acceptance of the bidder's offer shall form an agreement between the employer and the bidder upon the terms and conditions contained in this agreement and in the contract that is the subject of this agreement.
2. The terms of the contract, are contained in the bid document:
3. Deviations from and amendments to the documents listed in the bid data and any addenda thereto as listed in the bid schedules as well as any changes to the terms of reference of the offer agreed by the bidder and the employer during this process of offer and acceptance, are contained in the schedule of deviations attached to and forming part of this agreement. No amendments to or deviations from said documents are valid unless contained in this schedule, which must be signed by the authorized representative(s) of both parties.
4. The bidder shall within two weeks after receiving a completed copy of this agreement and order, including the schedule of deviations (if any), contact the employer's agent (whose details are given in the contract data) to arrange the delivery of any bonds, guarantees, proof of insurance and any other documentation to be provided in terms of the conditions of contract identified in the contract data at, or just after, the date this agreement comes into effect. Failure to fulfil any of these obligations in accordance with those terms shall constitute a repudiation of this agreement.
5. Notwithstanding anything contained herein, this agreement comes into effect on the date when the bidder receives one fully completed copy of this document, including the schedule of deviations (if any). Unless the bidder (now contractor) within five days of the date of such receipt notifies the employer in writing of any reason why he cannot accept the contents of this agreement, this agreement shall constitute a bidding contract between the parties.

NAME (PRINT) _____
CAPACITY _____
SIGNATURE _____
NAME OF FIRM _____
DATE _____

WITNESSES	
1.	_____
2.	_____
DATE:	_____

Schedule of Deviations

1 Subject _____
 Details _____

2 Subject _____
 Details _____

3 Subject _____
 Details _____

By the duly authorized representatives signing this schedule of deviations, the employer and the bidder agree to and accept the foregoing schedule of deviations as the only deviations from and amendments to the documents listed in the bid data and addenda thereto as listed in the bid schedules, as well as any confirmation, clarification or changes to the terms of the offer agreed by the bidder and the employer during this process of offer and acceptance.

It is expressly agreed that no other matter whether in writing, oral communication or implied during the period between the issue of the bid documents and the receipt by the bidder of a completed signed copy of this Agreement shall have any meaning or effect in the contract between the parties arising from this agreement.

For the bidder:

NAME (PRINT) _____
 CAPACITY _____
 SIGNATURE _____
 NAME OF FIRM _____
 DATE _____

WITNESSES	
1	_____
2	_____
DATE:	_____

For the Employer

NAME (PRINT) _____
 CAPACITY _____
 SIGNATURE _____
 NAME OF FIRM _____
 DATE _____

WITNESSES	
1	_____
2	_____
DATE:	_____

PART C2 – PRICING DATA

C 2.1

Pricing Instructions

EASTERN CAPE PROVINCIAL GOVERNMENT

DEPARTMENT OF RURAL DEVELOPMENT AND AGRARIAN REFORM

BID DOCUMENT FOR THE SUPPLY AND DELIVERY OF FENCING MATERIAL TO FARMS IN ENOCH MGIJIMA LOCAL MUNICIPALITY OF THE CHRIS HANI DISTRICT.

C2.1 Pricing Instructions

1. GENERAL

The Bill of Quantities forms part of the Contract Documents and must be read and priced in conjunction with all the other documents comprising the Contract Documents, which include the Conditions of Tender, Conditions of Contract, and the Specifications (Particular Specifications).

2. DESCRIPTION OF ITEMS IN THE SCHEDULE

The Bill of Quantities has been drawn up in accordance with the requirements of the equipment needed.

The short descriptions of the items in the Bill of Quantities are for identification purposes only and the measurement and payment clause of the Standardized Specifications and the Particular Specifications, read together with the relevant clauses of the Project Specification, set out what ancillary or associated work and activities are included in the rates for the items specified.

3. QUANTITIES REFLECTED IN THE SCHEDULE

The Works as finally completed in accordance with the Contract shall be measured and paid for as specified in the Bill of Quantities and in accordance with the General and Special Conditions of Contract, the Specifications and Project Specifications. Unless otherwise stated, items are measured net in accordance with the specifications, and no allowance has been made for waste.

The validity of the contract will in no way be affected by differences between the quantities in the Bill of Quantities and the quantities finally certified for payment.

4. PRICING OF THE BILL OF QUANTITIES

The prices and rates to be inserted by the tenderer in the Bill of Quantities shall be the full inclusive prices to be paid by the Employer for the work described under the several items, and shall include full compensation for all costs and expenses that may be required in and for the completion of all the work described and as shown as well as all overheads, profits, incidentals and the cost of all general risks, liabilities and obligations set forth or implied in the documents on which the tender is based.

Each item shall be priced and extended to the "Total" column by the tenderer, with the exception of the items for which only rates are required, or items which already have Prime Cost or Provisional Sums affixed thereto. If the tenderer omits to price any items in the Bill of Quantities, then these items will be considered to have a nil rate or price.

An item against which no price is entered will be considered to be covered by the other prices or rates in the Bills of Quantities. No additional payment or correction will be allowed after closing of tender.

All items for which terminology such as "inclusive" or "not applicable" have been added by the tenderer will be regarded as having a nil rate which shall be valid irrespective of any change in quantities during the execution of the Contract.

The tenderer shall fill in rates for all items where the words "rate only" appears in the "Total" column. "Rate Only" items have been included where:

- (a) an alternative item or material is contemplated;
- (b) variations of specified components in the make-up of a pay item may be expected; and

- (c) no work under the item is foreseen at tender stage but the possibility that such work may be required is not excluded.

For "Rate Only" items no quantities are given in the "Quantity" column but the quoted rate shall apply in the event of work under this item being required. The tenderer shall however note that in terms of the Tender Data the tenderer may be asked to reconsider any such rates which the Employer may regard as unbalanced.

All rates and amounts quoted in the Bill of Quantities shall be in rand and cents and shall include all levies and taxes (other than VAT). VAT will be added in the summary of the Bill of Quantities.

A price or rate is to be entered, in **BLACK INK**, against each item in the Bill of Quantities.

5. CORRECTION OF ENTRIES

Incorrect entries shall not be erased or obliterated with correction fluid but must be crossed out neatly. The correct figures must be entered above or adjacent to the deleted entry, and the alteration must be initialed by the tenderer.

6. ARITHMETICAL ERRORS

Arithmetical errors found in the Bill of Quantities because of faulty multiplication or addition, will be corrected by the Engineer at the tender evaluation stage, as set out in the Tender Data.

7. UNITS OF MEASUREMENT

The units of measurement described in the Bill of Quantities are metric units for which the standard international abbreviations are used. Non-standard abbreviations that may appear in the Bill of Quantities are as follows:

The units of measurement described in the Bills of Quantities are metric units. Abbreviations used in these Bills of Quantities are as follows:

%	=	percent
Dia	=	diameter
h	=	hour
ha	=	hectare
kg	=	kilogram
kl	=	kiloliter
km	=	kilometer
l	=	liter
m	=	meter
mm	=	millimeter
m ²	=	square meter
m ³	=	cubic meter
No.	=	number
Prov sum	=	Provisional sum
PC sum	=	Prime Cost sum
R/only	=	Rate only
sum	=	lump sum
t	=	ton (1000 kg)

C 2.2

Bill of Quantities

PRICING SCHEDULE – FIRM PRICES

(PURCHASES)

NOTE: ONLY FIRM PRICES WILL BE ACCEPTED. NON-FIRM PRICES (INCLUDING PRICES SUBJECT TO RATES OF EXCHANGE VARIATIONS) WILL NOT BE CONSIDERED

NAME OF BIDDER: _____

BID DOCUMENT FOR SUPPLY AND DELIVERY OF FENCING MATERIAL TO FARMS IN THE ENOCH MGIJIMA LOCAL MUNICIPALITY OF THE CHRIS HANI DISTRICT

SUMMARY OF PRICING SCHEDULE

Item 1: Supply and delivery of Fencing Material to Ntuthuko CPA As per Bill of Quantities	R _____
Item 2: Supply and delivery of Fencing Material to Tyhila farm As per Bill of Quantities	R _____
Sub Total 1	R _____
Add 5% Contingencies	R _____
Sub Total 2	R _____
15% Value Added Tax	R _____
Total Bid Amount	R _____

Total Bid Amount in Words: _____

- Does the offer comply with the specification(s)? *YES/NO
- If not to specification, indicate deviation(s)
- Period required for delivery
- Delivery basis
*Delivery: Firm/not firm

SIGNED: _____ NAME OF SIGNATORY (IN CAPITALS): _____

SIGNED ON THIS THE _____ DAY OF _____ OF THE YEAR 20_____

ON BEHALF OF _____

TELEPHONE NUMBER: (_____) _____ **FAX NUMBER:** (_____) _____

I/we choose domicilium citandi et executandi at _____
_____ in the Republic of
South Africa.

PAYMENT

- Part Payment will be made available after the full delivery of all materials for each site as per items as specified in the Bill of Quantities are verified according specifications of each site.
- Payment will only be effected after the Employer's Representative in the District has verified compliance as correct according to specifications.

The bid price shall include full compensation for supply, delivery, off-loading and staging of the fencing material at the mentioned sites.

BILL OF QUANTITIES

BID DOCUMENT FOR SUPPLY AND DELIVERY OF FENCING MATERIAL TO FARMS IN ENOCH MGJIMA LOCAL MUNICIPALITY OF THE CHRIS HANI DISTRICT

CONTRACT NO. SCMU8 - 21/22 - 0032

Having examined all the documents, I/we bid as follows:

ITEM 1: NTUTHUKO CPA

ITEM NO	DESCRIPTION	UNIT	QTY	RATE	AMOUNT
1	CORNER/STRAINING POLES 125 – 150mm x 2,1m Treated SANS Timber Poles	No	160		
2	BRACE POLES 100 – 125mm x 1,8m Treated SANS Timber Poles	No	96		
3	Y-STANDARDS Standards steel Y-Section 2,0kg/m x 1850mm	No	667		
4	TIMBER POSTS 75 – 100mm x 1.8m Treated SANS Timber Posts	Rate Only	=====		=====
5	RIDGEBACK DROPPERS Droppers Ridgeback steel 0,56kg/m x 1250mm	No	2000		
6	TIMBER DROPPER 32 – 50mm x 1,2m Treated SANS Timber droppers	Rate Only	=====		=====
7	WIRE BARBED Lightly Galv mild steel barbed wire, uni-coil 2 x 2,0mm (50kg Rolls)	No	99		
8	WIRE BINDING Lightly Galv mild steel wire 2,0mm (50kg Rolls)	No	8		
9	WIRE ANCHOR Lightly Galv mild steel wire 4,0mm (50kg Rolls)	No	8		
10	HEAVY DUTY FARM GATES: DIAMETER 42 X 2MM 3,6 x 1,2m gates with bolt and chain	No	8		
11	WIRE NETTING Lightly Galvanized netting wire 900 x 90 x 1,8mm	No	8		
12	DELIVERY Delivery to Ntuthuko CPA in Enoch Mgijima, 25km from Komani, delivery price must include remuneration of local labour for offloading	Lump Sum	1		
13	FENCING TRAINING	Prov Sum	1	R 3000	R 3000
14	FENCING TOOLS Wire stretcher Bobbejaan big chain	No	1		
	Tension indicator	No	1		
	D shackles 6mm dia (connect tension indicator and stretcher)	No	2		
	Digging Spade all steel	No	3		
	Crow bar 32 x 1800mm	No	2		
	Fencing pliers 300 mm	No	3		
	Scotch eyed auger bit 19 mm dia Grey color 600mm	No	1		
	Steel T bar auger handles	No	2		
	Steel hand held post driver	No	1		
TOTAL CARRIED TO SUMMARY OF PRICING SCHEDULE (Carry over to Summary)					

ITEM 2: TYHILA FARM

ITEM NO	DESCRIPTION	UNIT	QTY	RATE	AMOUNT
1	CORNER/STRAINING POLES 125 – 150mm x 2,1m Treated SANS Timber Poles	No	340		
2	BRACE POLES 100 – 125mm x 1,8m Treated SANS Timber Poles	No	204		
3	Y-STANDARDS Standards steel Y-Section 2,0kg/m x 1850mm	No	1417		
4	TIMBER POSTS 75 – 100mm x 1.8m Treated SANS Timber Posts	Rate Only	=====		=====
5	RIDGEBACK DROPPERS Droppers Ridgeback steel 0,56kg/m x 1250mm	No	4250		
6	TIMBER DROPPER 32 – 50mm x 1,2m Treated SANS Timber droppers	Rate Only	=====		=====
7	WIRE BARBED Lightly Galv mild steel barbed wire, uni-coil 2 x 2,0mm (50kg Rolls)	No	210		
8	WIRE BINDING Lightly Galv mild steel wire 2,0mm (50kg Rolls)	No	17		
9	WIRE ANCHOR Lightly Galv mild steel wire 4,0mm (50kg Rolls)	No	17		
10	HEAVY DUTY FARM GATES: DIAMETER 42 X 2MM 3,6 x 1,2m gates with bolt and chain	No	17		
11	WIRE NETTING Lightly Galvanized netting wire 900 x 90 x 1,8mm	No	17		
12	DELIVERY Delivery to Tyhila farm in Enoch Mgijima, 15km from Molteno, delivery price must include remuneration of local labour for offloading	Lump Sum	1		
13	FENCING TRAINING	Prov Sum	1	R 3000	R 3000
14	FENCING TOOLS Wire stretcher Bobbejaan big chain	No	3		
	Tension indicator	No	3		
	D shackles 6mm dia (connect tension indicator and stretcher)	No	6		
	Digging Spade all steel	No	9		
	Crow bar 32 x 1800mm	No	3		
	Fencing pliers 300 mm	No	9		
	Scotch eyed auger bit 19 mm dia Grey color 600mm	No	3		
	Steel T bar auger handles	No	6		
	Steel hand held post driver	No	3		
TOTAL CARRIED TO SUMMARY OF PRICING SCHEDULE (Carry over to Summary)					

C 3.1

Specifications

PARTICULAR SPECIFICATIONS – FENCING MATERIAL

PPS STOCK FENCING (SF)

PPS SF 1 MATERIALS AND DIMENSIONS

PPS SF 1.1 APPROVAL OF MATERIALS

The Contractor / Tenderer shall supply in good time to the Engineer, for his approval, samples of the following:

- Samples of all materials to be delivered.

PPS SF 1.2 LOCAL CONTENT

This bid document carries a minimum threshold for local content of 100% for all item that are locally manufactured such as:

- Steel products for construction (All fencing products including netting wire mesh)

PPS SF 1.3 CORNER-, STRAINING-, ANCHOR-, GATE POSTS, POSTS, DROPPERS AND BRACES

Corner-, Straining-, Anchor-, Gate Posts and Braces shall be wooden poles and of quality suitable for fencing and to the size indicated on the drawings.

Posts, Braces and droppers shall be treated and bearing the SANS mark. SANS 1288 (Copper-chrome arsenate treated timber) or SANS 05 (Creosote treated timber).

Corner-, Straining-, Anchor- and Gate Posts shall have a length of 2100 mm and a top diameter of between 125 to 150mm.

Timber posts shall have a length of 1800 mm and top diameter of between 75 to 100mm.

Timber droppers shall have a length of 1200 mm and top diameter of between 32 to 50 mm.

Braces shall have a length of minimum 1800 mm and a top diameter of between 100 to 125 mm.

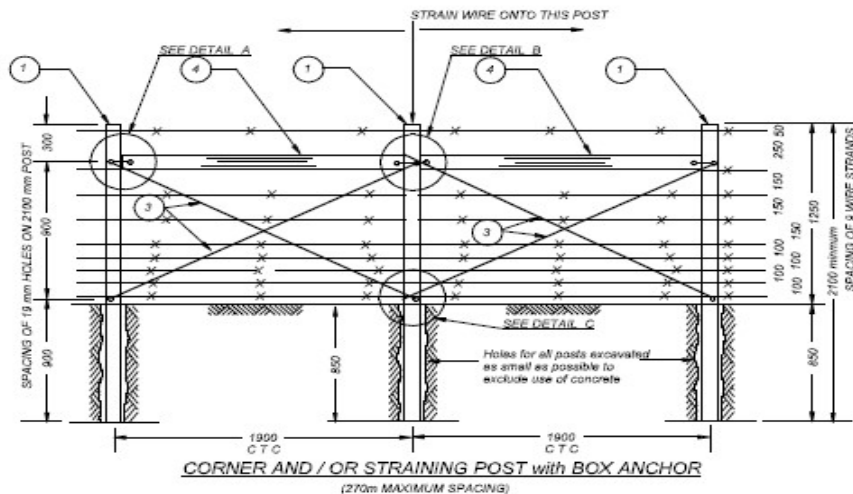

PPS SF 1.4 Y- STANDARDS

Standards shall be Y-section iron standards that has a mass of 2,0 kg/m and total length of 1850mm, that is a total mass of 3,7 kg for a 1850 mm length standard. The standards shall be provided with notches and holes 50mm apart. Standards shall be according to ISCOR Specifications SPE 261.

PPS SF 1.5 DROPPERS

Droppers shall be the Ridgeback iron droppers that has a mass of 0,56 kg/m and total length of 1250 mm. Droppers shall be according to ISCOR Specifications SPE 261.

PPS SF 1.6 WIRES

(i) Barbed wire

Barbed wire shall comply with the requirements of SANS 675 and shall be of the following type:

Mild-steel-grade lightly galvanized zinc-coated double-strand uni-directional twist wire, each strand 2,00 mm in diameter, for use at any height above ground.

Barbs shall be manufactured from 1,6mm lightly galvanized zinc-coated mild steel wire and shall be spaced at not more than 150 mm.

(ii) Smooth wire

The wire shall be Class A galvanized and comply with the requirements of SANS 675 and shall be of the type specified below:

Anchor wire shall be 4,00 mm diameter lightly galvanized zinc-coated mild steel wire.

Tying wire shall be 2,00 mm diameter mild-steel lightly galvanized zinc-coated wire for tying fencing wire to standards and droppers and 1,6 mm mild-steel lightly galvanized zinc-coated wire for tying netting and mesh wire to the fencing wire.

PPS SF 1.7 WIRE NETTING

Wire netting shall be lightly galvanized mild-steel wire with a minimum diameter of 1,8 mm, with 900 x 90 mm hexagonal mesh.

The width shall be as shown on the Bill of Quantities/drawings.

PPS SF 1.8 MANUFACTURING TOLERANCES FOR WIRES

The actual diameter of wire supplied shall equal the specified diameter subject to the appropriate tolerance given in SANS 675.

PPS SF 1.9 GATES

Gates shall be manufactured to the dimensions and details shown on the Bill of Quantities/Drawings. Gates shall be manufactured of mild steel tubing having continuously welded seams.

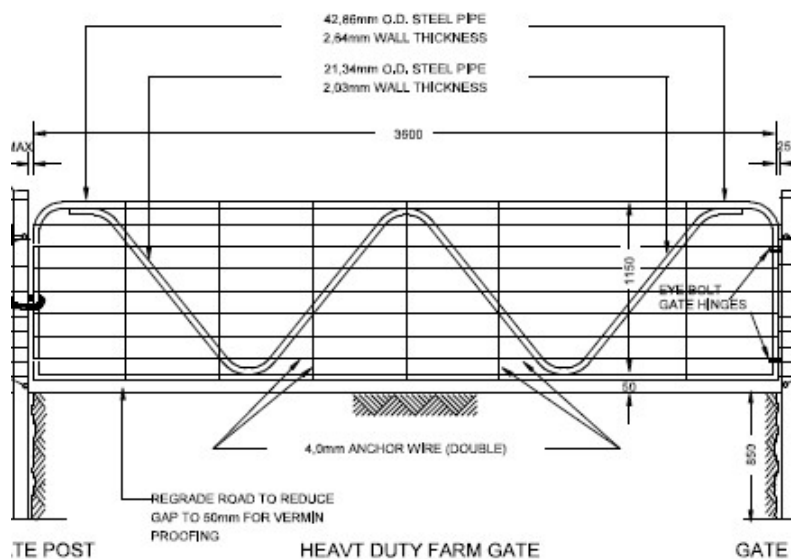

The frame shall be of tubing of bore 42 mm and wall thickness of 2,0 mm in the case of main frame members, and of a bore 22 mm and wall thickness of 2,0 mm in the case of bracing members. The width of each gate shall be as shown on the drawings.

Gates shall be complete in every respect, including hinges, washers, bolts and locking chains attached to the gate.

Gates shall be painted with 2 x coats rust preventative paint and finished with 2 x coats of Silver Shine Aluminum paint.

PPS SF 1.10 TIMBER POSTS FOR WIRE MATS

Timber posts for holding down wire mats where the fence crosses streams shall comply with the requirements of SANS 457 minimum diameter of 150 mm.

PPS SF 1.11 FENCING TOOLS

The fencing tools shall be as prescribed in the Bill of Quantities and as per the drawings on the next page.

PPS SF 1.12 FENCING TRAINING

The practical training must span a distance of no less than 100m and must include the following:

- 2x Box anchors
- Distance between iron standards
- Distance between droppers
- Straining box
- Number and configuration of strands according to laid down specifications.
- Binding of wire to anchors, iron standards and droppers.

This training span should take place close to the delivery site and should be available to be inspected by the Chief Engineer or representative thereof.

PPS SF 2 MEASUREMENT AND PAYMENT:

Item	Unit
-------------	-------------

PPS MEASUREMENT AND PAYMENT

PPS 1 Poles

Wooden, Creosote treated, 2,1m x (125-150mm).....Unit: No

The rates tendered shall cover the cost of supply and it will be measured in numbers.

PPS 2 Poles

Wooden, Creosote treated, 1.8m x (100-125mm)Unit: No

The rates tendered shall cover the cost of supply and it will be measured in numbers.

PPS 3 Iron standard

Y-standard 1.8m.....Unit: No

The rates tendered shall cover the cost of supply and it will be measured in numbers.

PPS 4 Droppers

Steel ridgeback 1.2m.....Unit: No

The rates tendered shall cover the cost of supply and it will be measured in numbers.

PPS 5 Wire barbed

2 x 2mm, lightly galvanizedUnit: No

The rates tendered shall cover the cost of supply and it will be measured in numbers

PPS 6 Wire binding

2,5mm mild steel, lightly galvanized.....Unit: No

The rates tendered shall cover the cost of supply and it will be measured in numbers

PPS 7 Wire Anchor

4mm mild steel, lightly galvanized.....Unit: No

The rates tendered shall cover the cost of supply and it will be measured in numbers

PPS 8 Wire netting

Lightly galvanised 1200 x 90mmUnit: No

The rates tendered shall cover the cost of supply and it will be measured in numbers

PPS 9 Gates

Farm gate heavy dutyUnit: No

The rates tendered shall cover the cost of supply and it will be measured in numbers

PPS 10 Fencing Tools

Fencing ToolsUnit: No

The rates tendered shall cover the cost of supply and it will be measured in numbers

PPS 11 Fencing Material Delivery

Fencing Material Delivery..... Lump Sum

The unit of measurement for the Fencing material delivery shall be the number of items delivered as per Bill of Quantities.

Fencing Training

TrainingUnit: Prov Sum

Fencing training will be paid under provisional sum

The tendered rates shall include full compensation for supply fencing materials, delivery fencing materials to the site, offloading and proper staging the fencing materials for ease of counting and checking at the specific site.

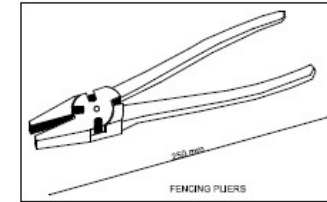
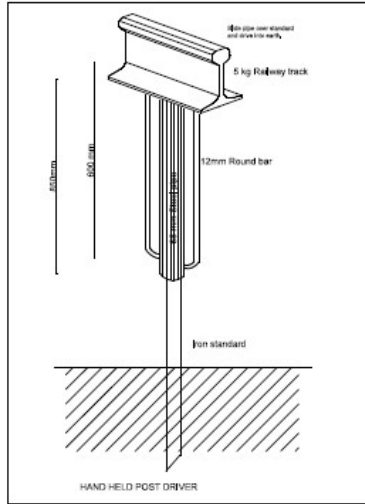
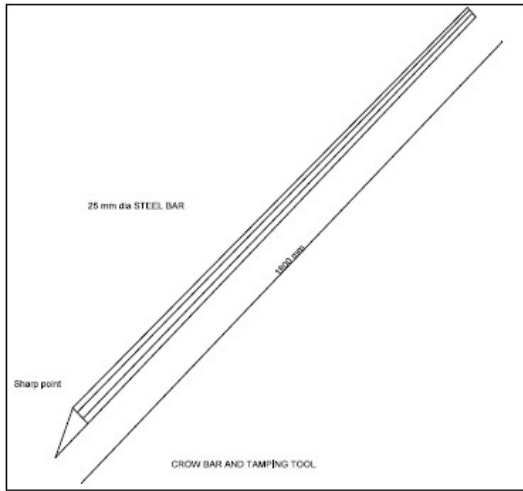
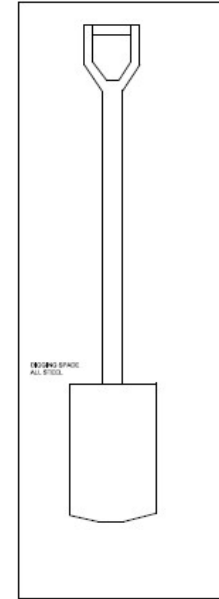
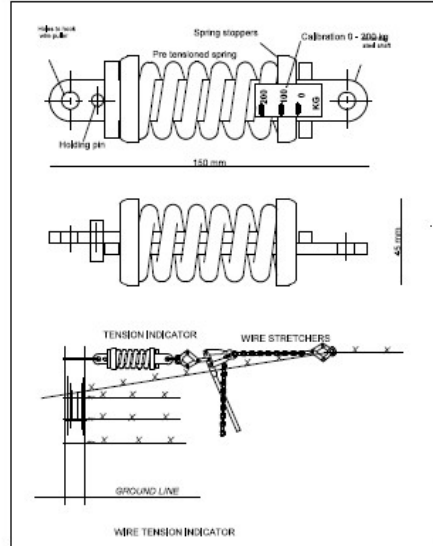
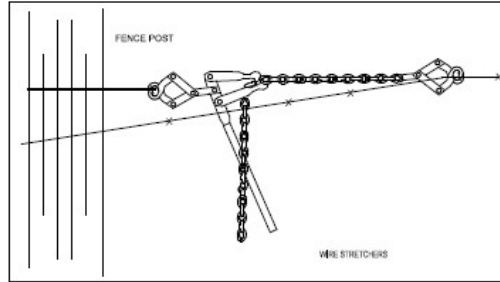
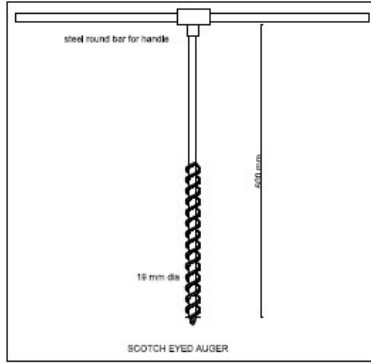

NO.	SPECIAL NOTES:

J.P.J. KOCH
(CHIEF ENGINEER)

DECEMBER 2020
(DATE APPROVED)

**DEPARTMENT OF RURAL DEVELOPMENT AND AGRARIAN REFORM
PROVINCE OF THE EASTERN CAPE**

ENGINEERING SERVICES
PRIVATE BAG X015
DOHINE ADJ
STUTTERHEIM
4930

STANDARD STOCK PROOF FENCE

1,2m HIGH = 3 STRAND FENCE

SCALE
NTS

A3 ORIGINAL

INDEX NO.
SCMM001/19/05

PLAN NO.
SHEET 6 OF 6

C 4.1

CONDITIONS OF CONTRACT

List of Conditions of Contract

EASTERN CAPE PROVINCIAL GOVERNMENT

DEPARTMENT OF RURAL DEVELOPMENT AND AGRARIAN REFORM

BID DOCUMENT FOR THE SUPPLY AND DELIVERY OF FENCING MATERIAL TO FARMS IN ENOCH MGIJIMA LOCAL MUNICIPALITY OF THE CHRIS HANI DISTRICT.

GENERAL CONDITIONS OF CONTRACT

The contract shall be governed by the “National Treasury General Conditions of Contract (July 2010). These General Conditions are available for inspection at the offices of the Departmental Head Office at Bhisho, Deputy Director: Supply Chain Management (SCM).

B. SPECIAL CONDITIONS OF CONTRACT

The Special Conditions of Contract form an integral part of the Contract. The Special Conditions of Contract shall amplify, modify or supersede, as the case may be, the General Conditions of Contract to the extent specified below, and shall take precedence and shall govern. **The following Special Conditions of Contract will apply.**

SECTION	SUBJECT
4. Standards	4.1 The material standards shall confirm to the Scope of Works (Project Particular Specifications)
7. Performance Security	7.1 No Performance Security is Required
9. Packing	9.2 <i>All packing material shall clearly indicate the contents of the materials inside the packing.</i>
10. Delivery of works/services	<p>10.1 <i>The Bidder will deliver the Services as requested to the Department as specified in the Scope of works (Project Particular Specifications) at the identified sites. A detail delivery note that include the full list of all the materials that are delivered shall be supplied by the service provider.</i></p> <p>10.2 <i>The Bidder will make delivery arrangements with the project leader for inspection of material to confirm compliance and verify the material and counting material.</i></p> <p>10.3 <i>The material will be sorted to the different items and stacked for easy counting.</i></p> <p>10.4 <i>The Bidder will complete the full project within the time frame stated after order received. (Maximum of 2 months (60 days) allowed to complete)</i></p>
11. Insurance	11.1 <i>Insurance shall cover all the materials and goods for the full period until such time as that the delivery note has been properly signed off by the Engineer’s Representative. NOT APPLICABLE IN THIS CONTRACT</i>
12. Transportation	12.1 <i>Delivery of materials to the different sites shall include full costs for the all-inclusive delivery of the materials and goods, the off-loading thereof and proper stacking for counting purposes.</i>
13. Incidental Services	13.1 <i>The Bidder is required to provide all services for the off-loading and proper packing/stacking of the materials at the sites.</i>
14. Spare parts	14.1 No spare parts are required from the supplier.
15. Warranty	<p>15.1 The warranty on all electrical equipment and pump equipment shall be for a minimum period of twelve months and shall commence from the date that the delivery note has been signed.</p> <p>15.2 The supplier shall repair or replace all goods under warranty within a period of four (4) weeks after receiving such notice from the purchaser.</p>
16. Payment	16.1 Part Payment will be made available after portions of the materials delivered to site, inspected and approved by the Engineer’s

	<p>Representative in line with the Bill of Quantities and verified according to specifications.</p> <p>16.2 Payment will be made within a period of 30 days after the receipt of the invoice.</p>
17. Prices	17.1 Prices charged by the supplier for services performed under the contract shall not vary from the prices quoted by the supplier in his bid.
21. Delays in the Bidders performance	<p>21.1 Delivery of the services and performance of services shall be made by the Bidder in accordance with the time schedule prescribed in the Bid Rules and Special Conditions of Contract (SCC) clause 10.4 in the contract.</p> <p>21.2 If at any time during performance of the contract, the Bidder or its supplier should encounter conditions impeding timely delivery of the performance of services, the Bidder shall promptly notify the Department in writing of the fact of the delay, its likely duration and its cause(s). As soon as practicable after receipt of the Bidder's notice, the Department shall evaluate the situation and may at his discretion extend the Bidder's time for performance, with or without the imposition of penalties, in which case the extension shall be ratified by the parties by amendment of contract.</p>
22. Termination for default.	<p>23.1 The Department, without prejudice to any other remedy for breach of contract, by written notice of default sent to the supplier, may terminate this contract in whole or in part:</p> <p>(a) if the bidder/supplier fails to deliver any or all of the services within the period(s) specified in the contract, or within any extension thereof granted by the Department;</p> <p>(b) if the bidder/supplier fails to perform any other obligation(s) under the contract; or</p> <p>(c) if the bidder/supplier, in the judgment of the Department, has engaged in corrupt or fraudulent practices in competing for or in executing the contract.</p>
23. Force Majeure	25.2 If a force majeure situation arises, the bidder/supplier shall promptly notify the Department in writing of such condition and the cause thereof. Unless otherwise directed by the Department in writing, the bidder/supplier shall continue to perform its obligations under the contract as far as is reasonably practical, and shall seek all reasonable alternative means for performance not prevented by the force majeure event.
24. Termination for insolvency.	26.1 The Department may at any time terminate the contract by giving written notice to the bidder/supplier if the bidder/supplier becomes bankrupt or otherwise insolvent. In this event, termination will be without compensation to the bidder/supplier, provided that such termination will not prejudice or affect any right of action or remedy which has accrued or will accrue thereafter to the Department.
25. Settlement of Disputes	<p>27.1 The parties may at any time, without prejudice to any other proceedings, agree to settle any claim or any dispute amicably with the help of an impartial third party. Amicable settlement may include any settlement technique as agreed to by the parties.</p> <p>27.2 Amicable settlement shall become final and binding on the parties only to the extent that it is correctly recorded as being agreed to by the parties.</p>
26. Applicable law	30.1 The contract shall be interpreted in accordance with South African Laws.
GENERAL ITEMS	<p>1. The bid forms are drawn up so that certain essential information is to be furnished in a specific manner. Any additional particulars shall be furnished in a separate questionnaire or in a separate annexure.</p> <p>2. The Preference Claim and other relevant forms, attached, shall be completed, signed and submitted with the bid. Documentary proof as substantiation of preferences claimed and to the satisfaction of the</p>

	<p>Department, should be handed in with the bid.</p> <ol style="list-style-type: none"> 3. Where items are specified in detail, the specifications form an integral part of the bid document and bidders shall indicate in the space provided whether the items offered are to specification or not. Failure to complete, will automatically disqualify the Bid for any further consideration. 4. In respect of the paragraphs where the items offered are strictly to specification, bidders shall insert the words "as specified". 5. In cases where the items are not to specification, the deviations from the specifications shall be indicated. 6. The bid prices shall be given in the units shown. 7. All prices shall be quoted in South African currency. 8. Delivery basis: <ol style="list-style-type: none"> (a) Supplies which are held in stock or are in transit or on order from South African manufacturers at the date of bidding, shall be offered on a basis of delivery into consignee's store or on his site within the free delivery area of the bidder's centre, or carriage paid consignee's station if the goods are required elsewhere. (b) Notwithstanding the provisions of paragraph 8(a), bid prices for supplies in respect of which installation/erection/assembly is a requirement, shall include ALL costs on a basis of delivered on site as specified. 9. No bids transmitted by telegram, telex, facsimile or similar apparatus shall be considered. 10. Failure on the part of the bidder to sign this bid form and thus to acknowledge and accept the conditions in writing or to complete the attached forms, questionnaires and specifications in all respects, may invalidate the BID. 11. Bids should be submitted on the official forms and should not be qualified by the bidder's own conditions of bidding. Failure to comply with these requirements or to renounce specifically the bidder's own conditions of bidding, when called upon to do so, may invalidate the bid. 12. The bid forms should not be retyped or redrafted but photocopies may be prepared and used. Additional offers may be made for any item but only on a photocopy of the page in question or on other forms obtainable from the relevant Institution. Additional offers made in any other manner may be disregarded. 13. Black ink shall be used to fill in bids. No unauthorized alteration shall be made to the document. Mistakes made by the Bidders in the completion of the pricing schedule, forms, etc. shall not be erased nor erasing fluid used. A line shall be drawn through the incorrect entry and the correct entry shall be written above and the correction initialed by the Bidders. Bid may also be rejected if they show any additional items not originally included in the Bid documents, conditional or incomplete offers, irregularities of any kind in either the Bid form or the priced schedule, or if the rates and amounts quoted in the schedule are obviously unbalanced and the Bidders, after having been called upon to adjust same in a reasonable manner, fails to do so within a period of seven days of having received notification to that effect. 14. The Bidder shall satisfy himself that the documents received are correct, complete and sufficient to be the basis of a <i>bona fide</i> Bid. Bidders shall check the numbers of the pages and satisfy themselves that none are missing or duplicated. No liability shall be accepted in
--	--

	<p>regard to claims arising from the fact that pages are missing or duplicated. Should a Bidder not accept that the documents issued can form the basis of a <i>bona fide</i> Bid the SCM Unit shall be requested to correct the discrepancy, ambiguity, missing or illegible information prior to the submission of Bid. The submission of a <i>bona fide</i> Bid shall absolve the Employer from any liability whatsoever for any error in a Bid due to the foregoing.</p> <p>15. The relevant consultant/contractor agrees that should any dispute arise from the contract, the matter shall be submitted to the relevant Bid Adjudication Committee for a ruling and such ruling shall be final.</p> <p>16. In the event that the bidder is not the actual manufacturer and will be sourcing the product(s) from another company, an unconditional letter (or certificate: confirmation of supply arrangements between the bidder and his/her supplier) from the company(ies)/supplier(s) confirming supply arrangement(s) in this regard, has to accompany the bid at the closing date and time of bid. The said company/supplier must confirm that it has familiarized itself with the item description, specifications and bid conditions and if the bid consist of more than one item, it should be clearly indicated in respect of which item(s) the supportive letter has been issued. It must be indicated in the above-mentioned letter that all financial arrangements with regard to payment between the prospective bidder and manufacturer/company/supplier issuing such a letter has been finalized and terms and conditions mutually agreed upon. Non-compliance with the above-mentioned special conditions would automatically invalidate the bid for such products offered.</p> <p>17. The Bid must be signed by one duly authorized to do so. In the case of a Bid being submitted on behalf of a Company, Close Corporation, Partnership or Joint Venture, such Bid shall be accompanied by a certified copy of a resolution of the Board of Directors of such Company, Close Corporation or other suitable authority in the case of a Partnership or Joint Venture, in terms of which the nominee is authorised to sign on behalf of the business entity.</p> <p>The joint venture documentation is also to clearly state that all its parties will remain severally and jointly bound for the duration of the defects liability period, as well as setting out how matters will be dealt with that may arise as latent defects once the joint venture has dissolved.</p> <p>If due to any unforeseen reasons the joint venture dissolves during the defects liability period, the agreement must clearly state how the liability will be dealt with in terms of honoring all the responsibilities it may still have with regards to the due performance of all contractual issues that could arise.</p> <p>18. These conditions form part of the bid/ price quotation and failure to comply therewith may invalidate a bid/ price quotation.</p>
--	---