

GATE SECTION 1 (GS1)

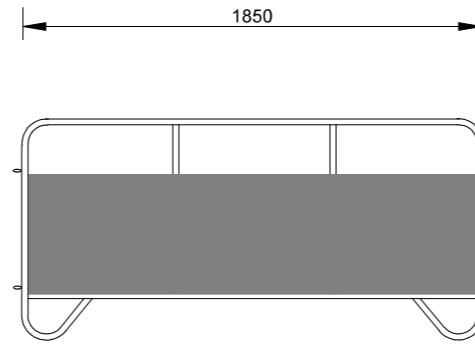

GATE SECTION 4 (GS4)

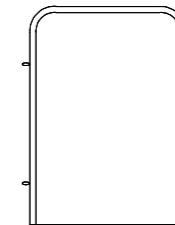

Premanufactured Arch Frame

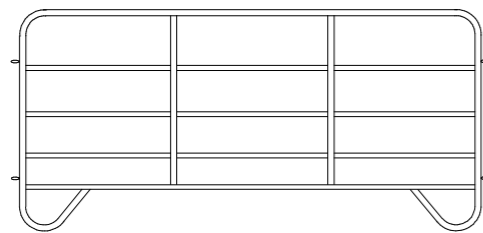

GATE SECTION 2 (GS2)

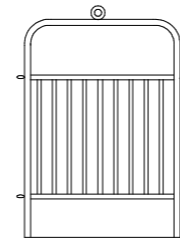

GATE SECTION 5 (GS5)

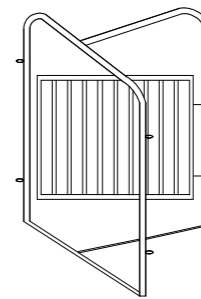

GATE SECTION 7 (GS7)

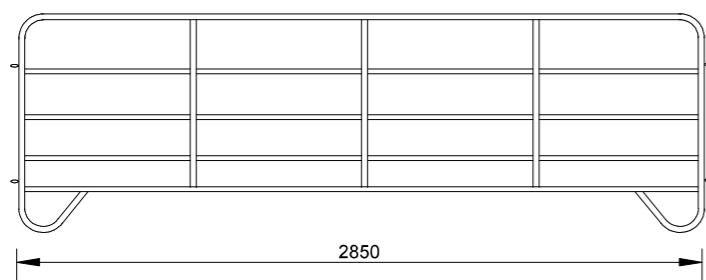

GATE SECTION 3 (GS3)

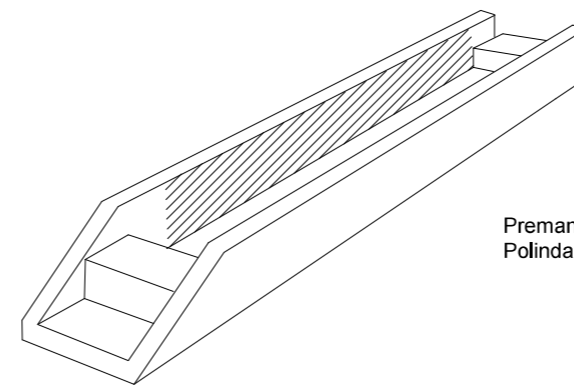

PREFABRICATED FOOT BATH

SPECIAL NOTES:	PROJECT:	DEPARTMENT OF RURAL DEVELOPMENT AND AGRARIAN REFORM	REV NO.	DATE	DRAWN BY
	PRE-FABRICATED SHEEP GATE SECTIONS	EASTERN CAPE	001	30/05/2011	DCJ de Villiers
		ENGINEERING SERVICES	DRAWING TITEL:	PRE-FARBICATED GATE SECTION	
			DRAWING NUMBER:	DRDAR SCMM-01/2020 PRE-FAB 1 OF 1	