

**GATE SECTION 1 (GS1)**

Premanufactured sheep gate  
(Taltec TSK 3 or similar)

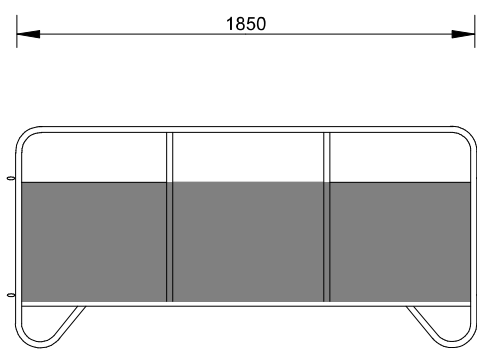

**GATE SECTION 4 (GS4)**

Premanufactured sheep Crush section  
(Taltec TSK 2 or similar)

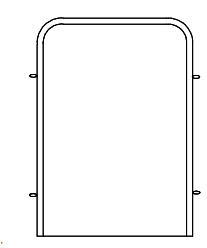

Premanufactured Arch Frame

**GATE SECTION 6 (GS6)**

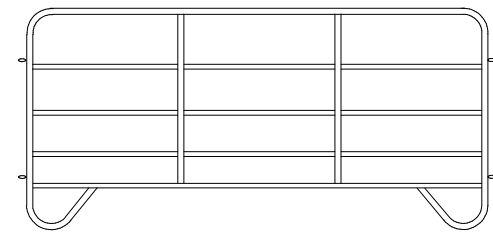

**GATE SECTION 2 (GS2)**

Premanufactured sheep gate  
(Taltec TSK 1 or similar)

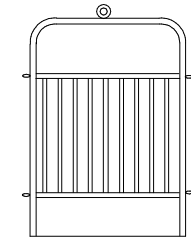

Premanufactured Guillotine gate  
(Taltec TSK 4 or similar)

**GATE SECTION 5 (GS5)**

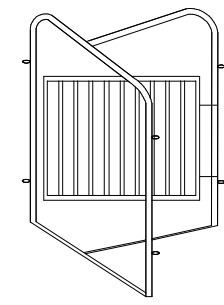

Premanufactured Sorting gate  
(Taltec TSK 5 or similar)

**GATE SECTION 7 (GS7)**

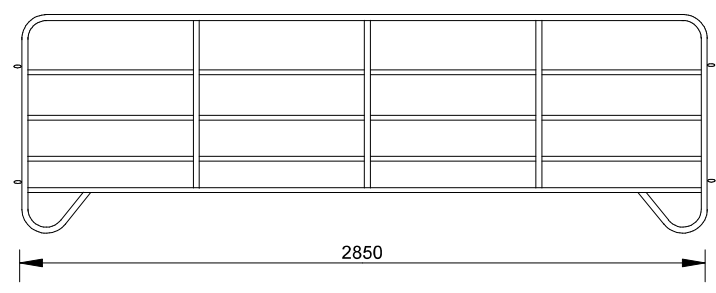

**GATE SECTION 3 (GS3)**

Premanufactured sheep gate  
(Taltec TSK 1 or similar)

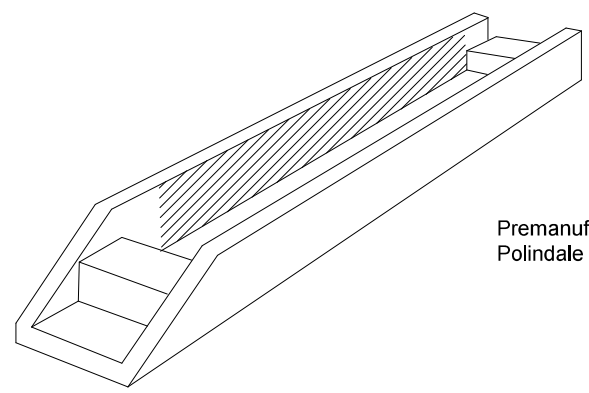

Premanufactured Sheep foot bath  
Polindale or similar approved.

**PREFABRICATED FOOT BATH**

NO.	SPECIAL NOTES:	JPJ KOCH (CHIEF ENGINEER)	DEPARTMENT OF RURAL DEVELOPMENT AND AGRARIAN REFORM PROVINCE OF THE EASTERN CAPE	SMALL STOCK PRE-FABRICATED HANDLING FACILITIES	SCALE	INDEX NO.
					NTS	SCMM001/25/01
	DECEMBER 2020 (DATE APPROVED)		ENGINEERING SERVICES PRIVATE BAG X015 DOHNE ADI STUTTERHEIM 4930	GENERAL VIEW	A3 ORIGINAL	PLAN NO. SHEET 1 OF 1