

Premanufactured sheep gate
(Taltec TSK 3 or similar)

GATE SECTION 1 (GS1)

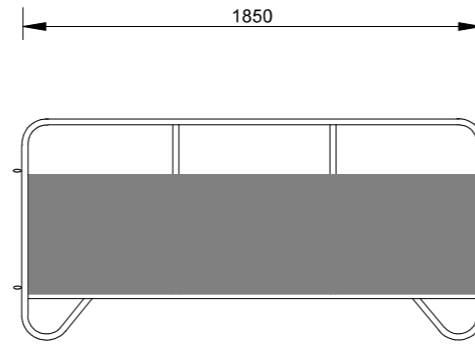

Premanufactured sheep Crush section
(Taltec TSK 2 or similar)

GATE SECTION 4 (GS4)

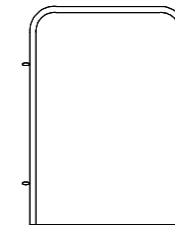

Premanufactured Arch Frame

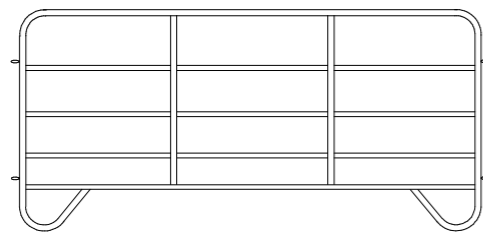

Premanufactured sheep gate
(Taltec TSK 1 or similar)

GATE SECTION 2 (GS2)

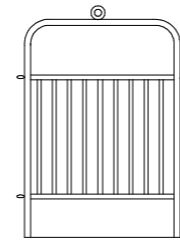

Premanufactured Guillotine gate
(Taltec TSK 4 or similar)

GATE SECTION 5 (GS5)

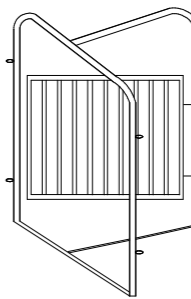

Premanufactured Sorting gate
(Taltec TSK 5 or similar)

GATE SECTION 6 (GS6)

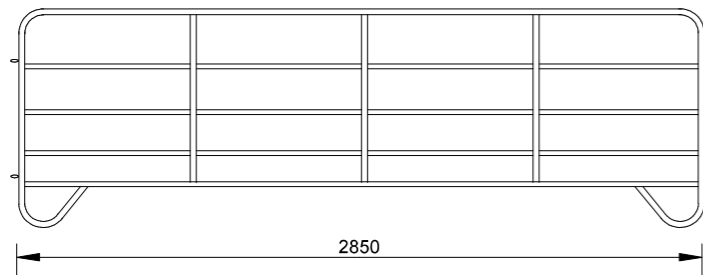

Premanufactured sheep gate
(Taltec TSK 1 or similar)

GATE SECTION 3 (GS3)

GATE SECTION 7 (GS7)

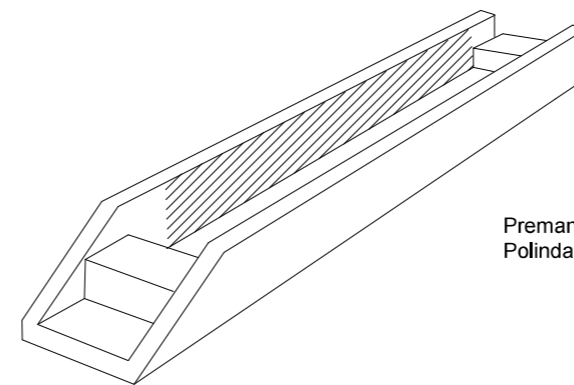

Premanufactured Sheep foot bath
Polindale or similar approved.

PREFABRICATED FOOT BATH

SPECIAL NOTES:

PROJECT:

**PRE-FABRICATED SHEEP
GATE SECTIONS**

DEPARTMENT OF RURAL DEVELOPMENT AND AGRARIAN REFORM

**EASTERN CAPE
ENGINEERING SERVICES**

REV NO.

001

DATE

30/05/2011

DRAWN BY

DCJ de Villiers

DRAWING TITEL:

PRE-FABRICATED GATE SECTION

DRAWING NUMBER:

DRDAR SCMM-01/2020
PRE-FAB 1 OF 1