

Premanufactured sheep gate
(Taltec TSK 3 or similar)

GATE SECTION 1 (GS1)

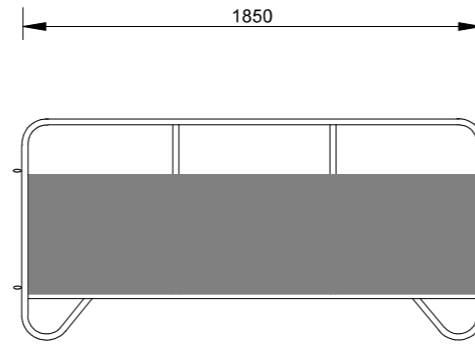

Premanufactured sheep Crush section
(Taltec TSK 2 or similar)

GATE SECTION 4 (GS4)

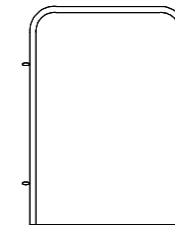

Premanufactured Arch Frame

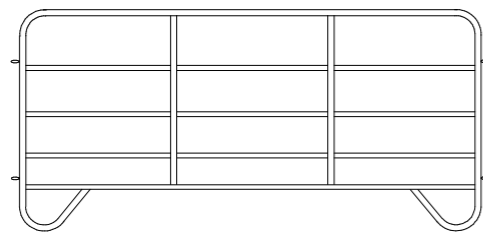

Premanufactured sheep gate
(Taltec TSK 1 or similar)

GATE SECTION 2 (GS2)

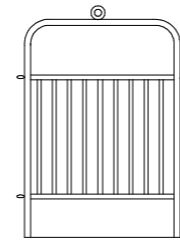

Premanufactured Guillotine gate
(Taltec TSK 4 or similar)

GATE SECTION 5 (GS5)

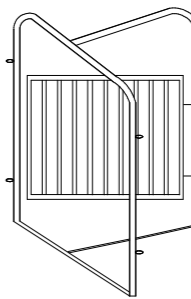

Premanufactured Sorting gate
(Taltec TSK 5 or similar)

GATE SECTION 6 (GS6)

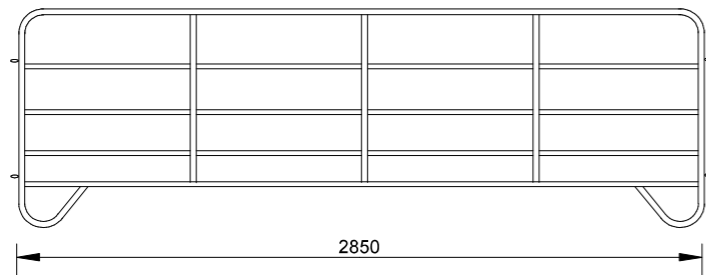

Premanufactured sheep gate
(Taltec TSK 1 or similar)

GATE SECTION 3 (GS3)

GATE SECTION 7 (GS7)

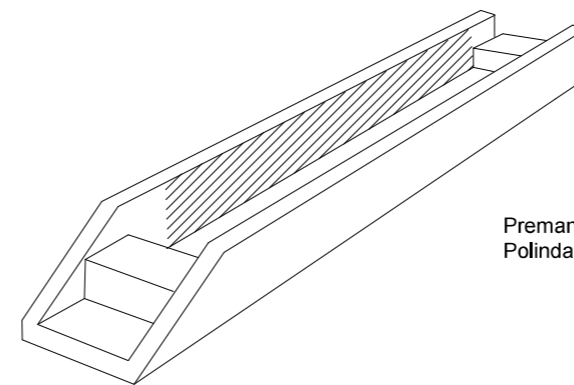

Premanufactured Sheep foot bath
Polindale or similar approved.

PREFABRICATED FOOT BATH

SPECIAL NOTES:

PROJECT:

**PRE-FABRICATED SHEEP
GATE SECTIONS**

DEPARTMENT OF RURAL DEVELOPMENT AND AGRARIAN REFORM

**EASTERN CAPE
ENGINEERING SERVICES**

| | | |
|-----------------|--------------------------------------|-----------------|
| REV NO. | DATE | DRAWN BY |
| 001 | 30/05/2011 | DCJ de Villiers |
| DRAWING TITEL: | PRE-FABRICATED GATE SECTION | |
| DRAWING NUMBER: | DRDAR SCMM-01/2020 PRE-FAB 1 OF 1 | |